

# AATSR Calibration and Validation

Dr David Smith  
STFC Rutherford Appleton Laboratory  
Chilton, Didcot  
Oxfordshire  
OX11 0QX  
United Kingdom

E-mail: [dave.smith@stfc.ac.uk](mailto:dave.smith@stfc.ac.uk)

# What is ATSR?

- The **A**long **T**rack **S**canning **R**adiometer - **ATSR** for short
  - an imaging space-borne infrared radiometer
- Designed in the **early 1980's by UK and Australian scientists** – who were then ahead of their time in recognising climate change as an important issue.
  - **Specifically** designed to measure sea surface temperature (SST) for:
    - a) **climate change detection – the first sensor aimed at this task!**
    - b) to support a range of oceanography studies
  - Later capabilities added for land, cloud, and aerosol remote sensing
- Three instruments have been flown over the last 15 years on ESA EO missions:
  - ATSR(-1) on ERS-1 (now lost) – **initial experimental instrument**
  - **ATSR-2 on ERS-2**
  - **AATSR on ENVISAT**

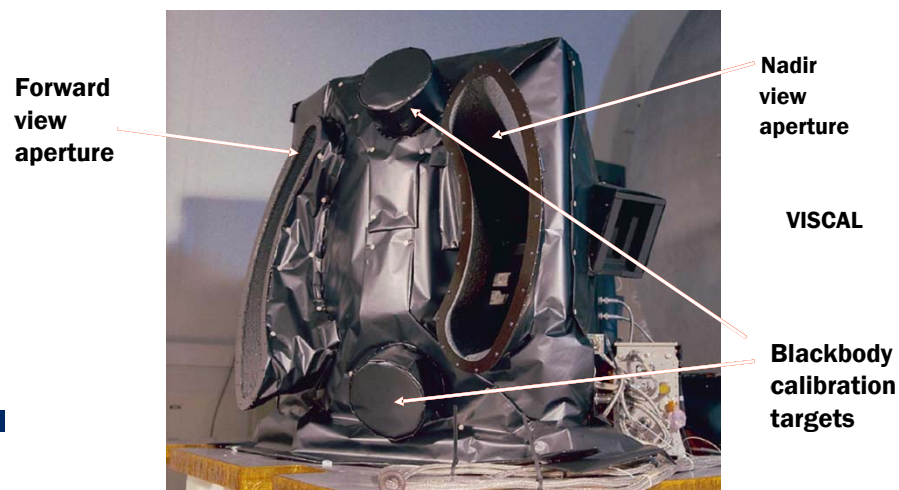

# ATSR viewing geometry – ground track

Forward view is the  
2 x shortest path to surface  
i.e. more absorption

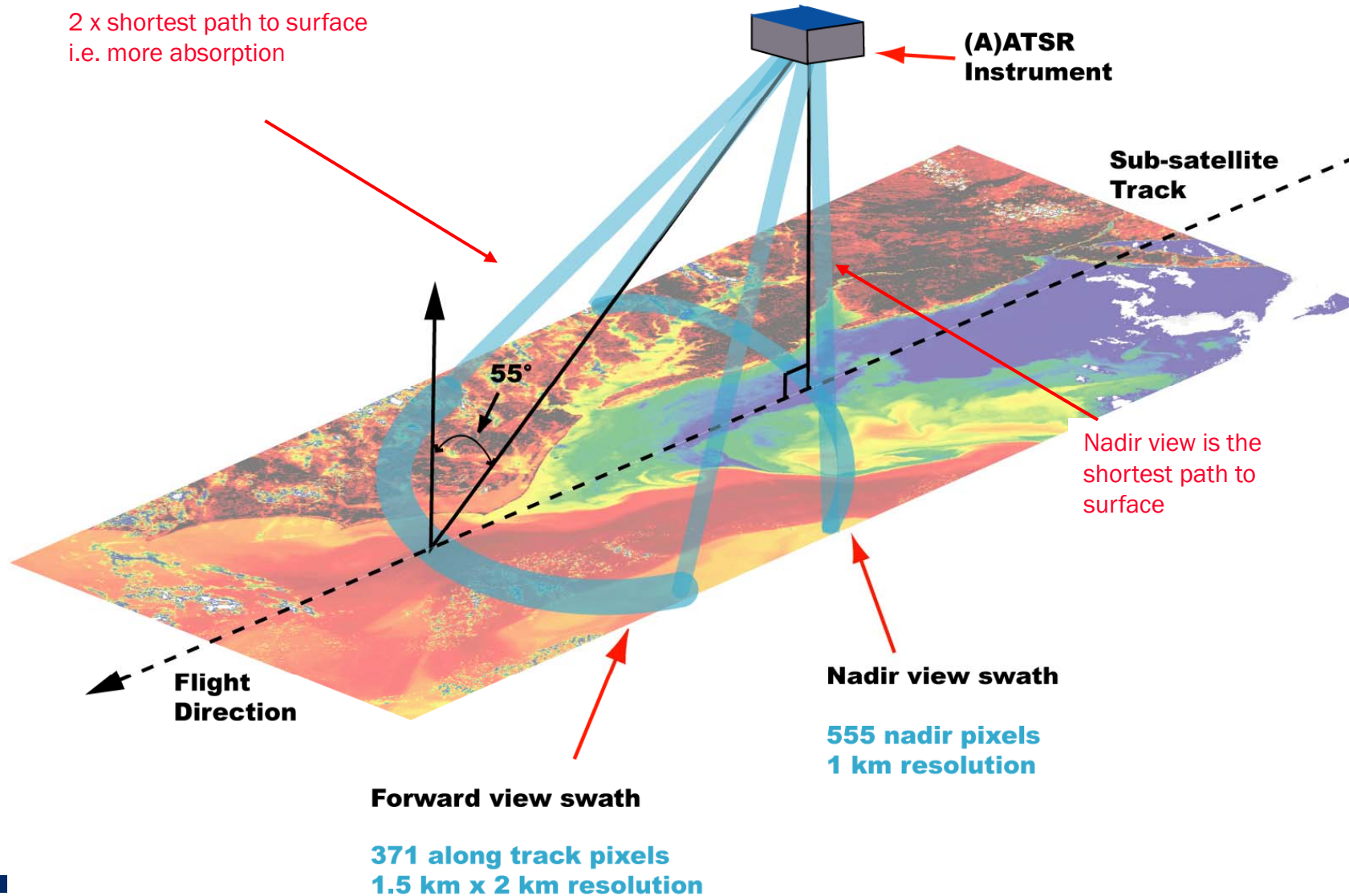

## Design Features - Channels

- Thermal IR channels at 12 $\mu\text{m}$ , 11 $\mu\text{m}$  and 3.7 $\mu\text{m}$ 
  - Actively cooled to 80K using a Stirling cycle cooler
- Visible/Near Infrared Channels at 1.6 $\mu\text{m}$ , 0.87 $\mu\text{m}$ , 0.66 $\mu\text{m}$  and 0.56 $\mu\text{m}$

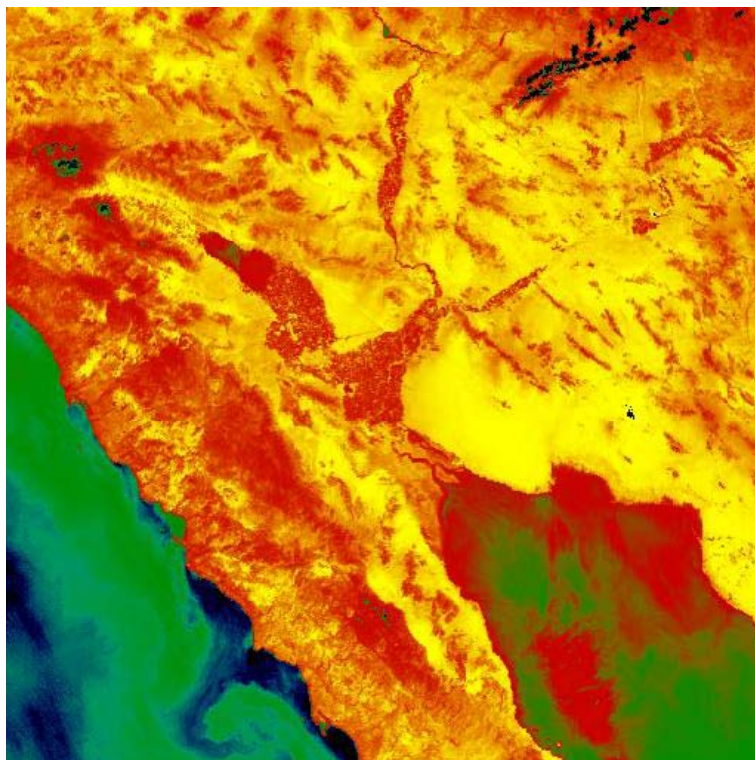

# Infra-Red Calibration System

**Blackbodies viewed every scan.**

- Blackbody calibration targets designed by MSSL
- 2-point scheme covering the range of expected SST
  - Cold bb ~300K
  - Hot bb ~256K
- High Emissivity >0.999
- Precision Thermometry
  - 5 baseplate sensors
  - Calibration traceable to ITS-90
- **Same BB Heritage as used on IASI, Gerb**

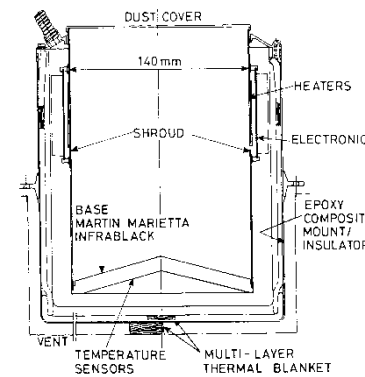
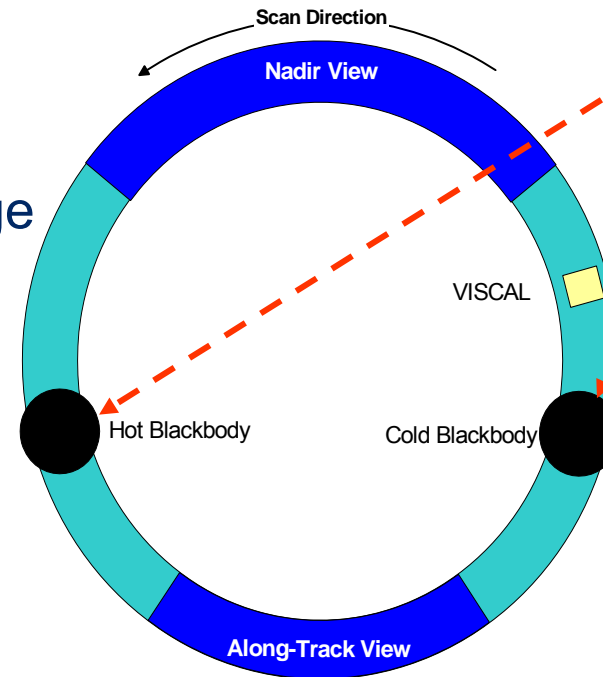

# Sea Surface Temperatures

- Dual view allows aerosol robust SST retrieval

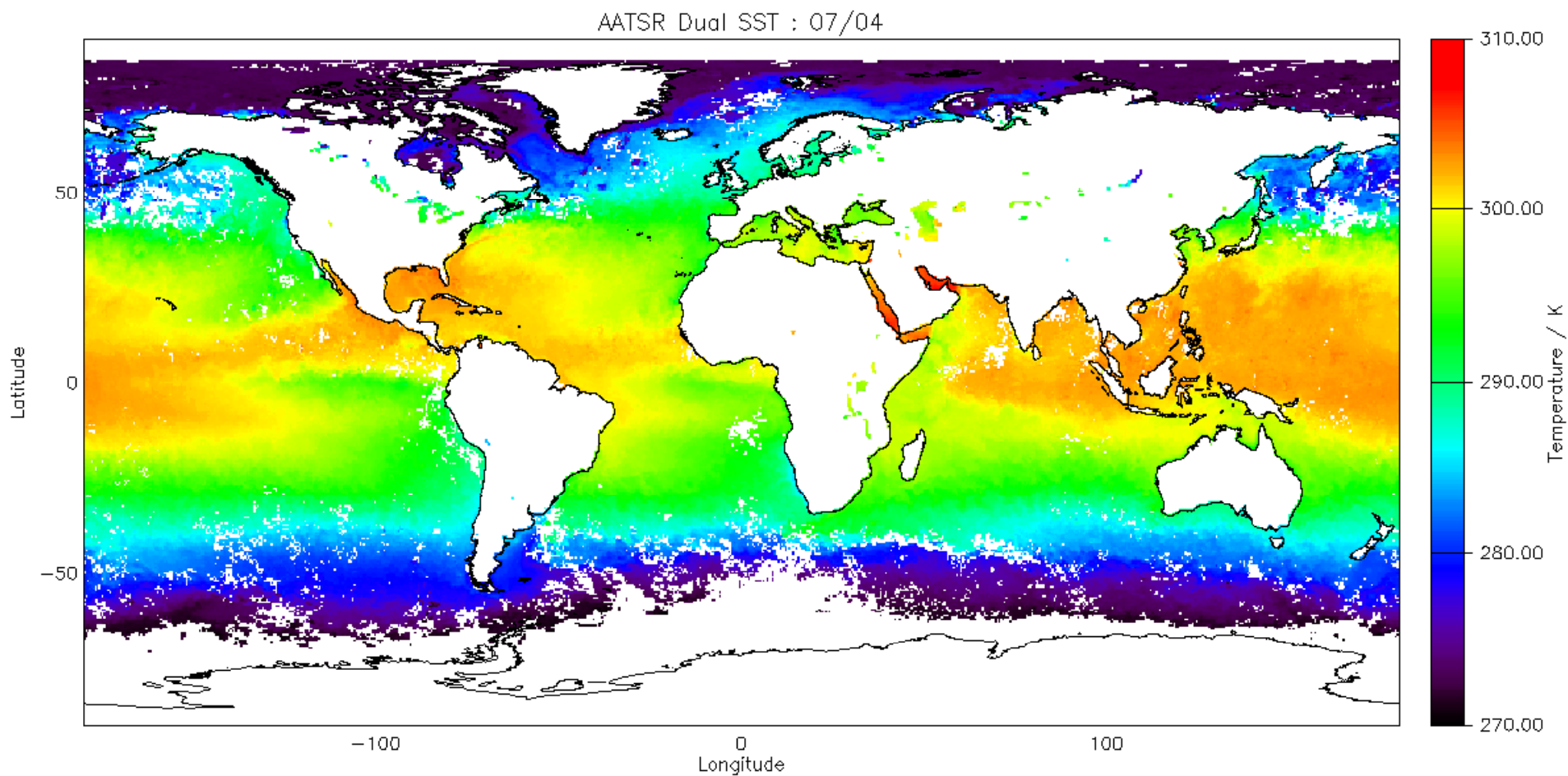

# ATSR Series

1991-2000 ATSR-1

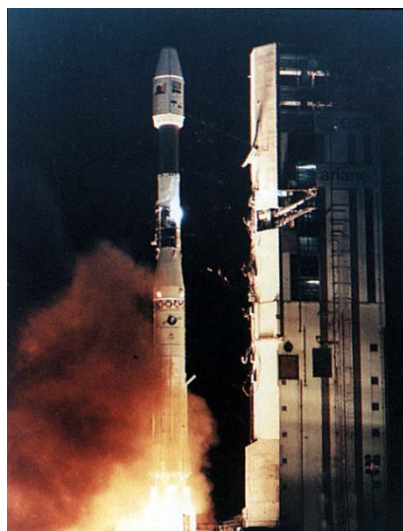
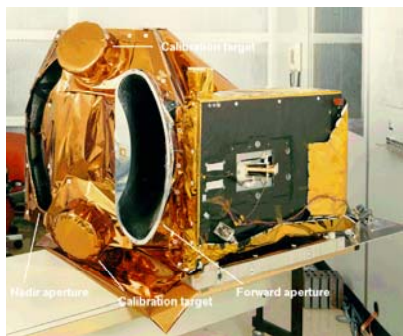

1995-2008 ATSR-2

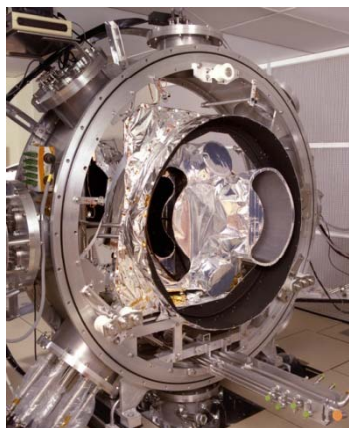

2002- AATSR



# ATSR Series Timeline

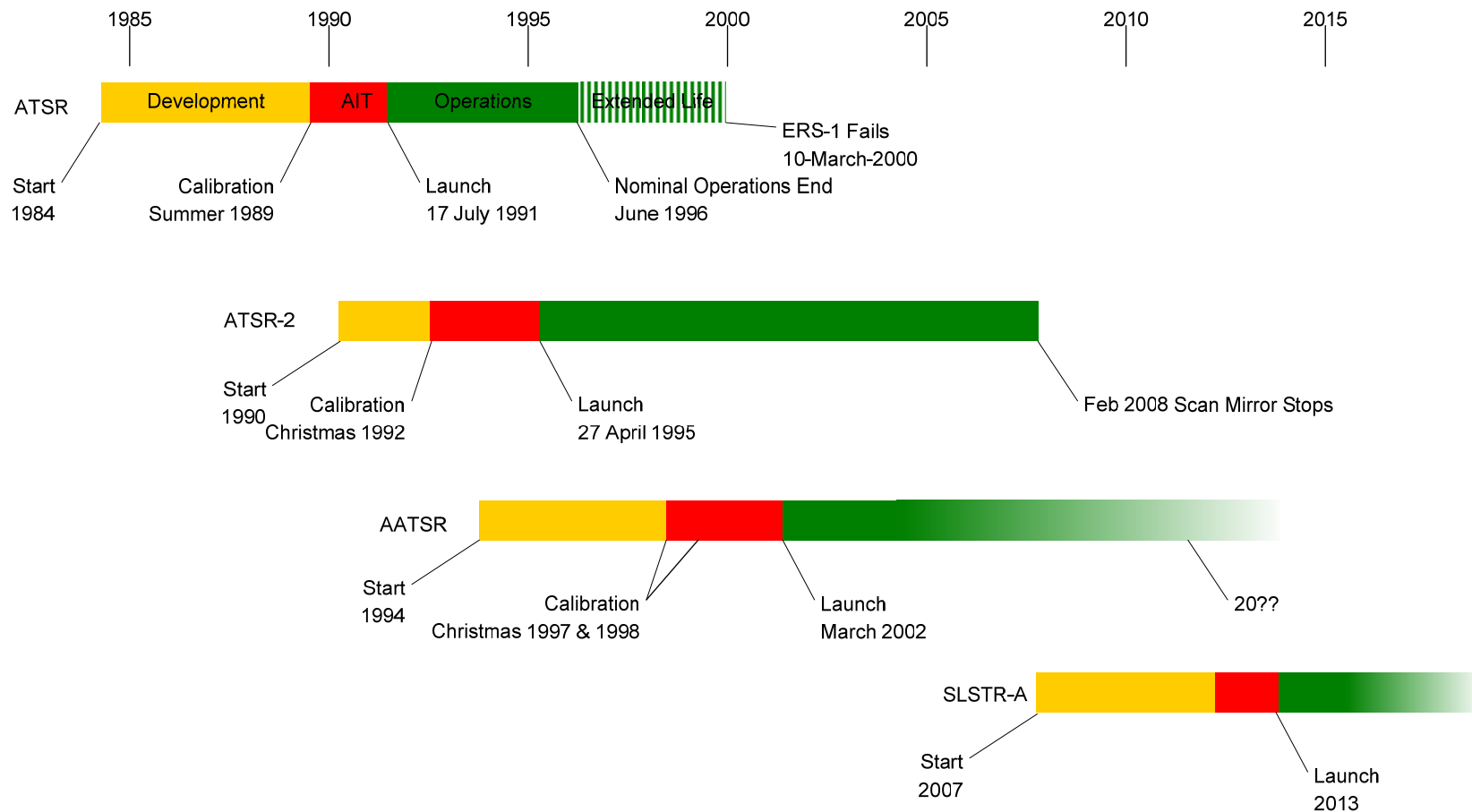



# Cooler Performance

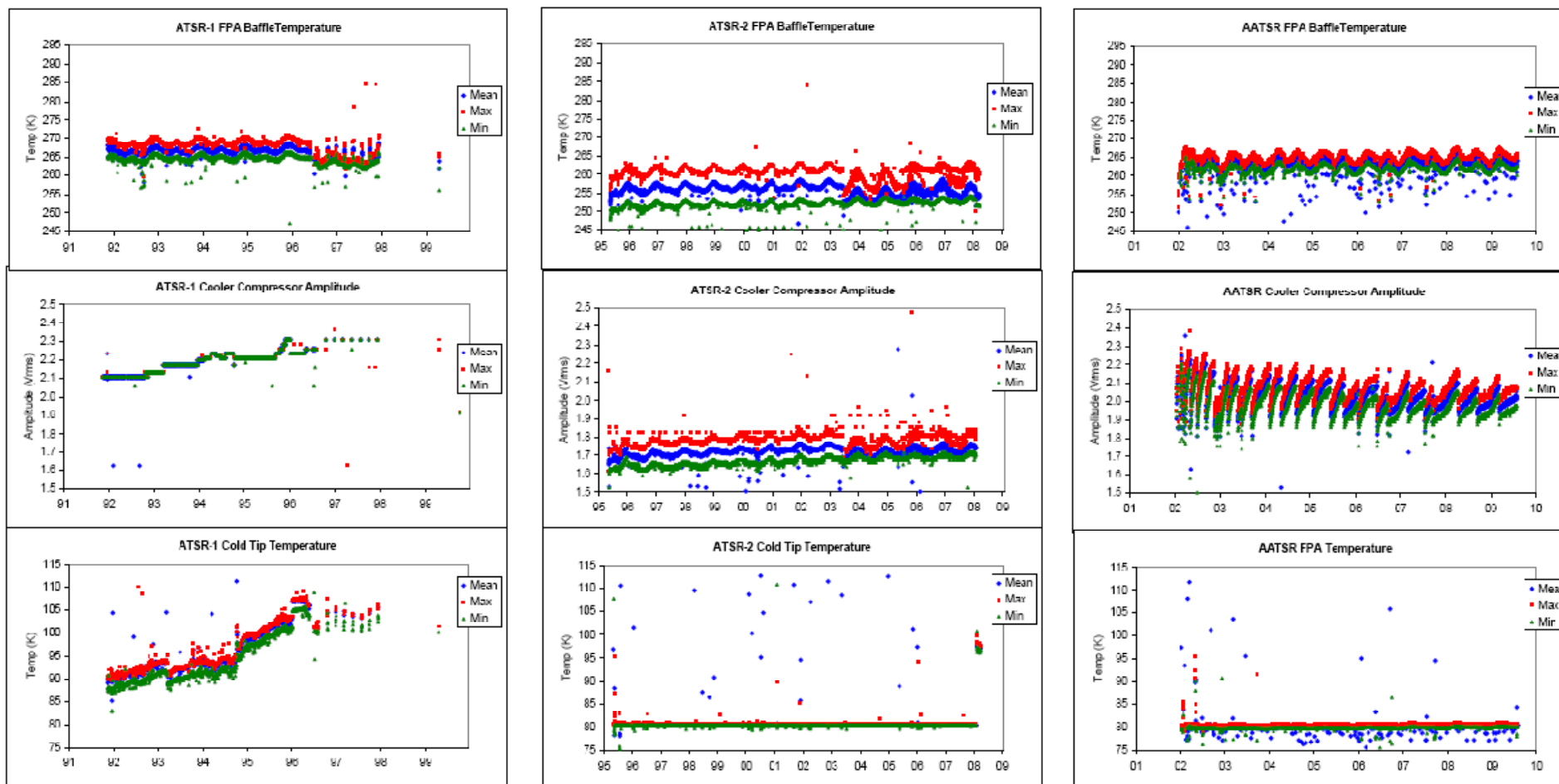

# Detector Performance

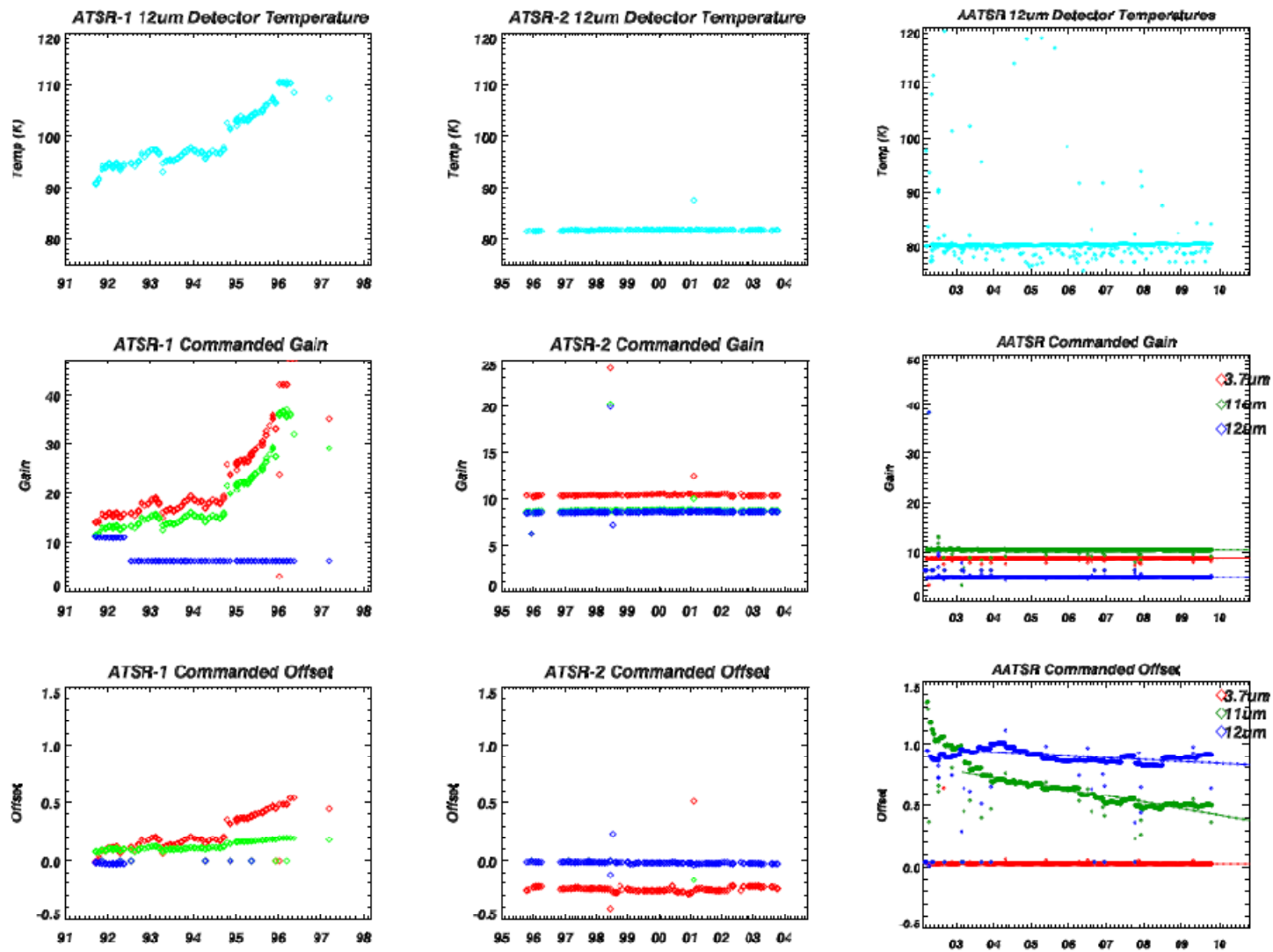

# Radiometric Noise Performance

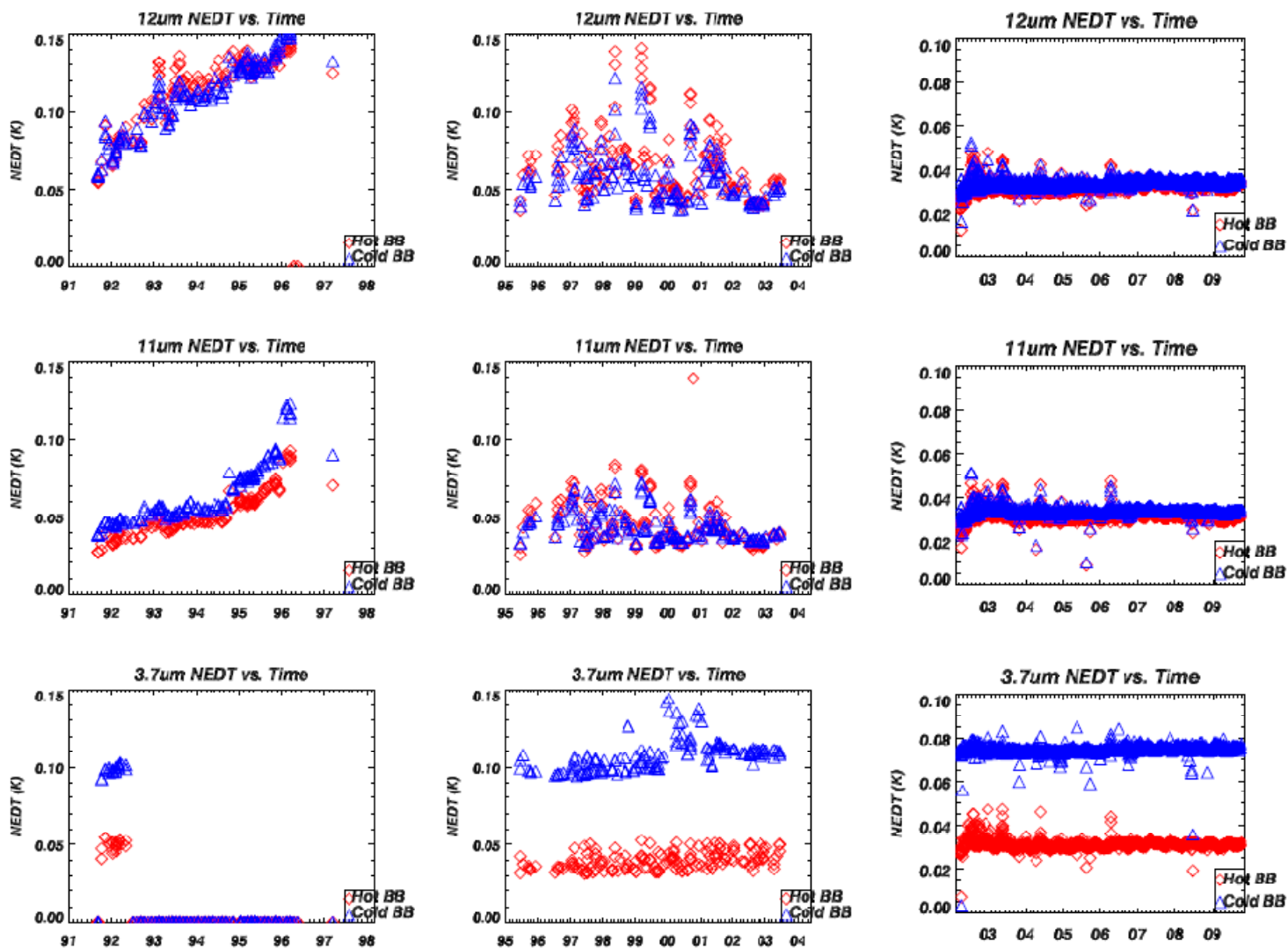

# Blackbody Performance

ATSR-1

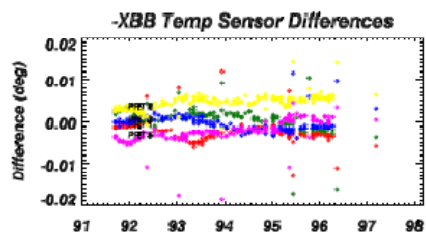
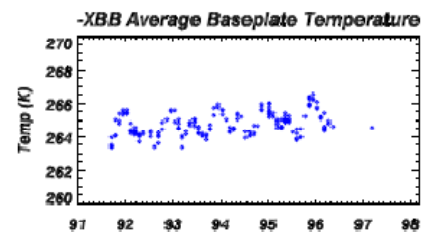
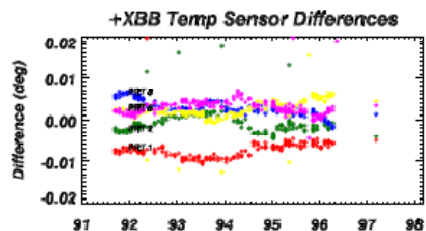
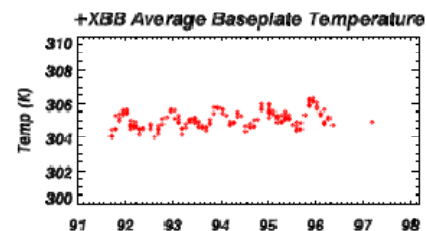

ATSR-2

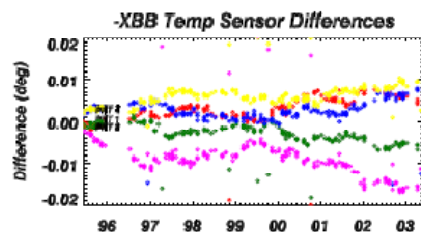
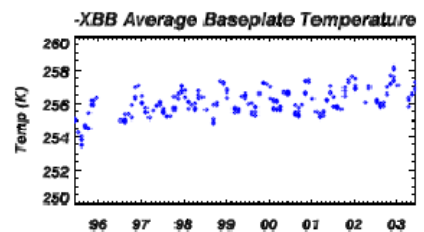
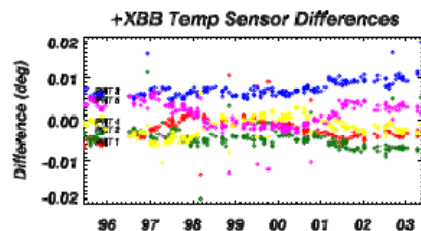
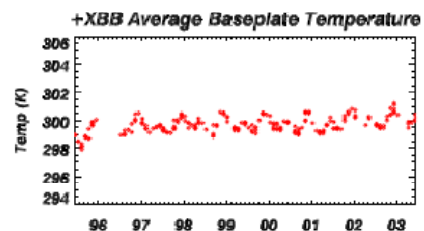

AATSR

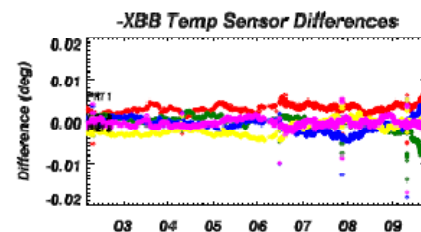
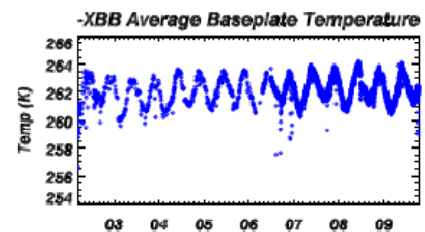
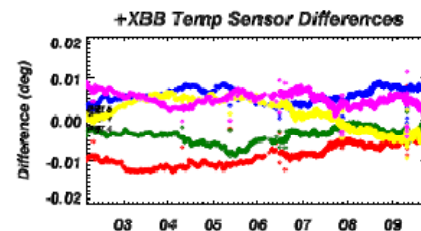
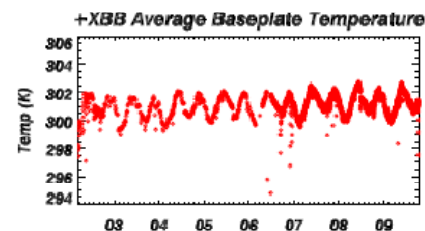

# ATSR: Long Term Stability

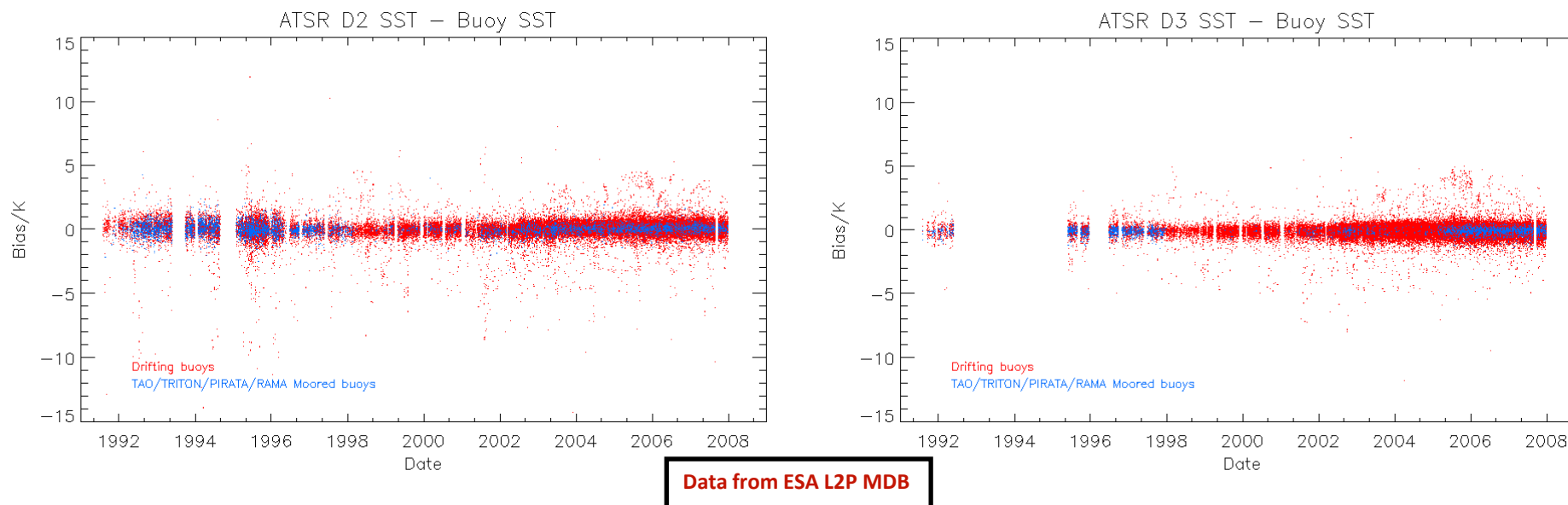

- Match-ups of 1-km SST and nearest buoy observation within 1-km and 120 minutes
- No post-filtering, hence large number of outliers
- Match-ups shown for drifting buoys and TAO/TRITON/PIRATA/RAMA arrays

# ATSR: Long-term accuracy

## ATSR versus drifters

ATSR	Number	Mean (K)	SD (K)	Median (K)	RSD (K)
AATSR Night (3-ch)	10682	+0.09	0.36	+0.11	0.32
ATSR-2 Night (3-ch)	5349	+0.07	0.61	+0.07	0.37
ATSR-1 Night (3-ch)	252	+0.08	0.78	+0.07	0.50

Data from ESA L2P MDB

## Buoy (sub-skin) vs. AATSR (sub-skin) and Radiometer (skin) vs. AATSR (skin)

Reference	Buoy			Radiometer		
	No.	Mean (K)	SD (K)	No.	Mean (K)	SD (K)
ISAR Night	752	+0.03	0.27	1130	+0.02	0.24
M-AERI Night	372	+0.10	0.31	936	+0.09	0.29

Data from Peter Minnett (RSMAS), Werenfrid Wimmer (NOCS) and Medspiration MDB

# AATSR VISCAL

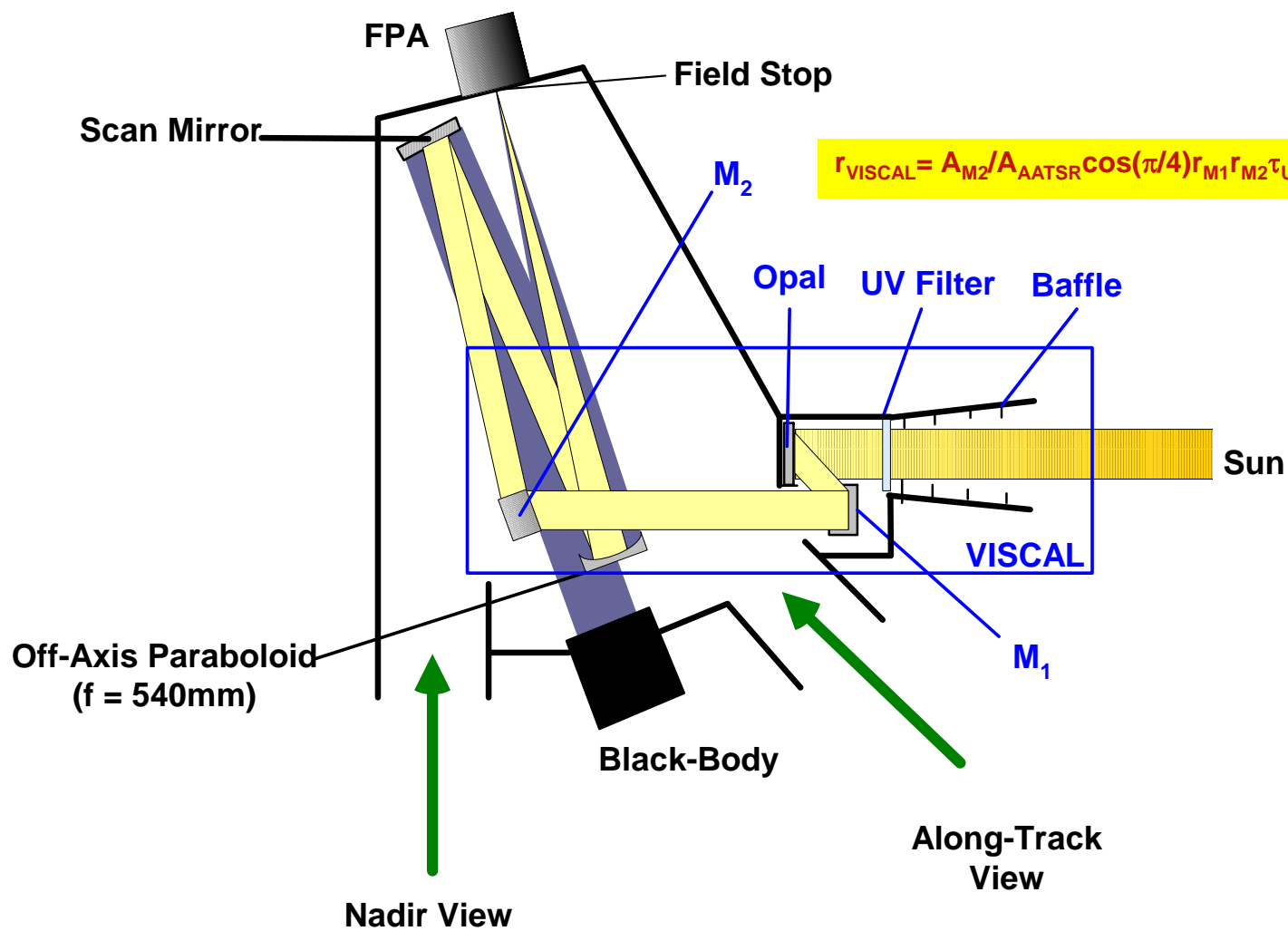

## Vicarious Calibration Using Stable Targets

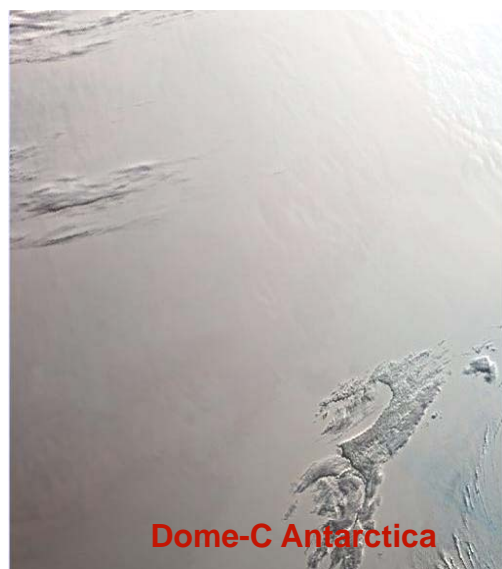
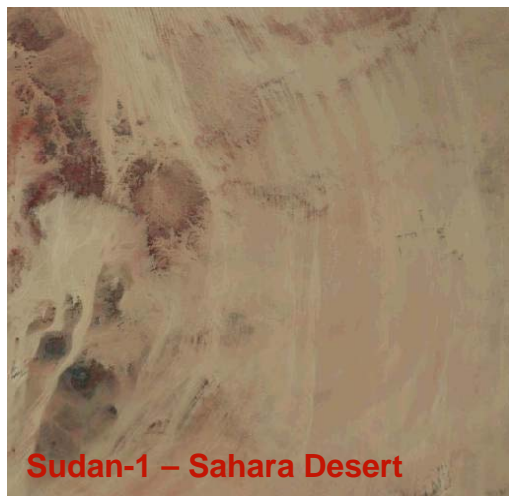

- Large area desert and ice sites can provide a useful site for vicarious calibration optical sensors measuring reflected Sunlight such as AATSR
- Key Assumptions
  - Uniform reflectance over large area
  - Long term-radiometric stability of the calibration sites ensures long-term stability of the top-of-the atmosphere (TOA) albedo (and of seasonal variations, if any) or reflectance over large spatially uniform areas.
  - High surface reflectance to maximise the signal-to-noise and minimise atmospheric effects on the radiation measured by the satellite



# Long-Term Trend Analysis

- Long Term Drift established by comparing against reference measurements
  - i.e.  $D(t) = R(t)/R_{ref}$
  - Stable reference sensor – e.g. MERIS
  - Reference BRDF – derived from early measurements, model, ground measurements

# Calibration Sites

	Lat center (°)	Long center (°)	
Sahara	Algeria1	23.8	-0.4
	Algeria2	26.09	-1.38
	Algeria3	30.32	7.66
	Algeria4	30.04	5.59
	Algeria5	31.02	2.23
	Arabia1	18.88	46.76
	Arabia2	20.13	50.96
	Arabia3	28.92	43.73
	Sudan1	21.74	28.22
	Niger1	19.67	9.81
	Niger2	21.37	10.59
	Niger3	21.57	7.96
	Egypt1	27.12	26.1
	Libya1	24.42	13.35
	Libya2	25.05	20.48
	Libya3	23.15	23.1
	Libya4	28.55	23.39
	Mali1	19.12	-4.85
Mauritania1	19.4	-9.3	
Mauritania2	20.85	-8.78	
Other Deserts	Dunhuang	40.095	94.155
	Sonora	31.8	-113.86
	Hay	-34.382	145.292
	Amburla	-23.285	133.119
	Thangoo	-18.1	122.26
Ice	Greenland	73.75	-40
	Antarctica	-73.75	120

# AATSR Drift Monitoring Procedure

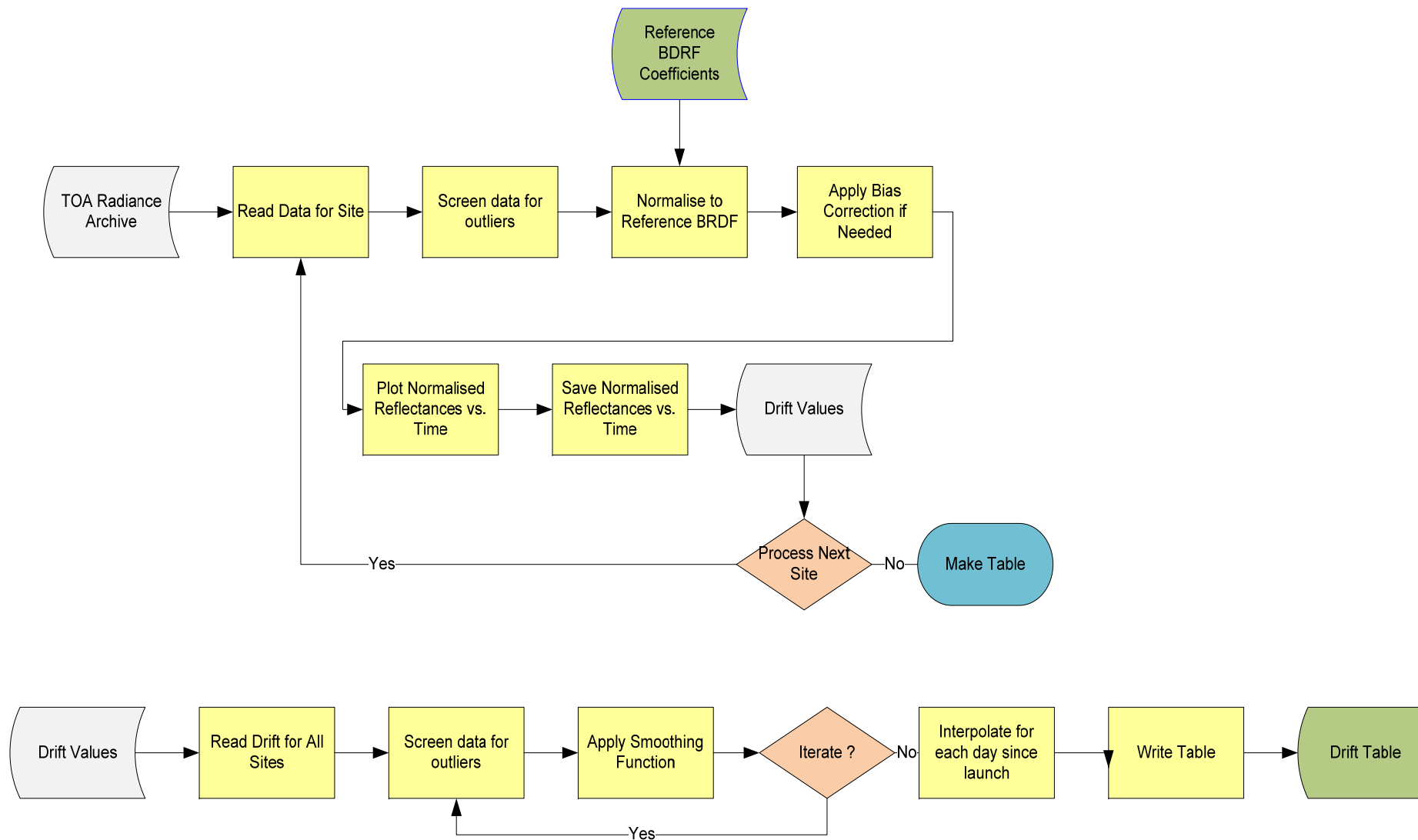

# ATSR-2 Desert BRDF measurements

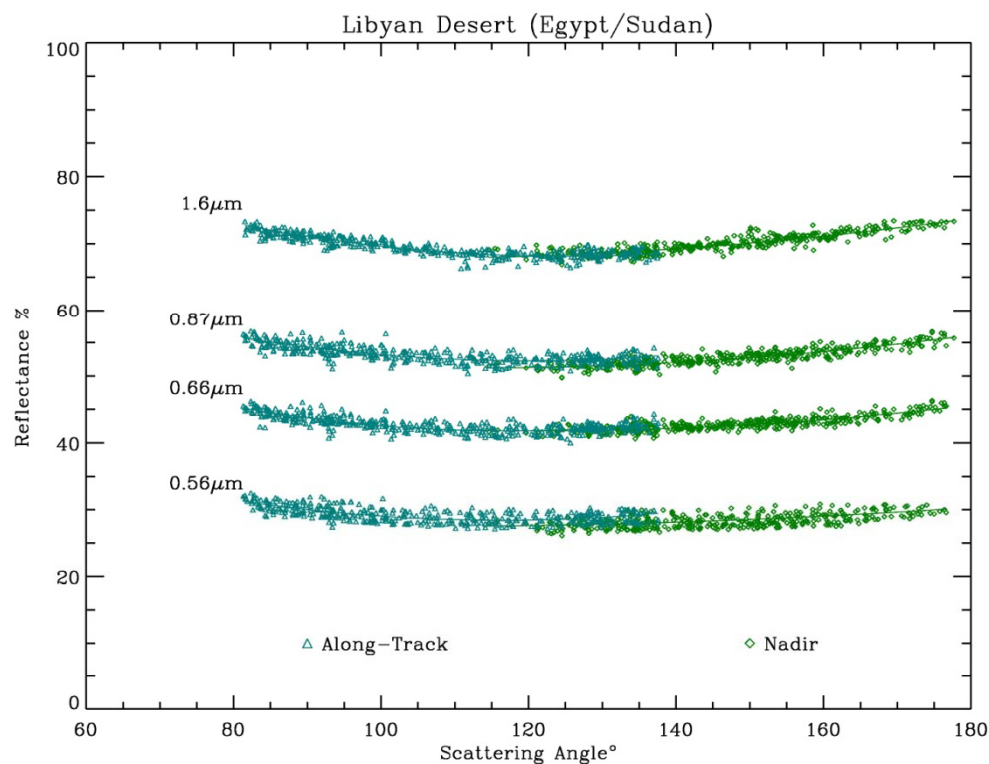

ATSR-2  
TOA reflectance archive  
from 1995 to 2000

Coefficients for ATSR-2 BRDF for site SUDAN1 ( $R = a_0 + a_1\gamma + a_2\gamma^2$ )

	Nadir			Along Track		
	$a_0$	$a_1$	$a_2$	$a_0$	$a_1$	$a_2$
1.6μm	78.2736053	-0.2023685	0.0009938	106.6791382	-0.6175243	0.0024774
0.87μm	65.2568512	-0.2483396	0.0010956	85.1799927	-0.5492774	0.0022903
0.67μm	56.3275871	-0.2425693	0.0010161	77.0637436	-0.5996294	0.0025522
0.56μm	34.4137306	-0.1228843	0.0005610	60.6836205	-0.5556419	0.0023956

# ATSR-2 Long Term Drift

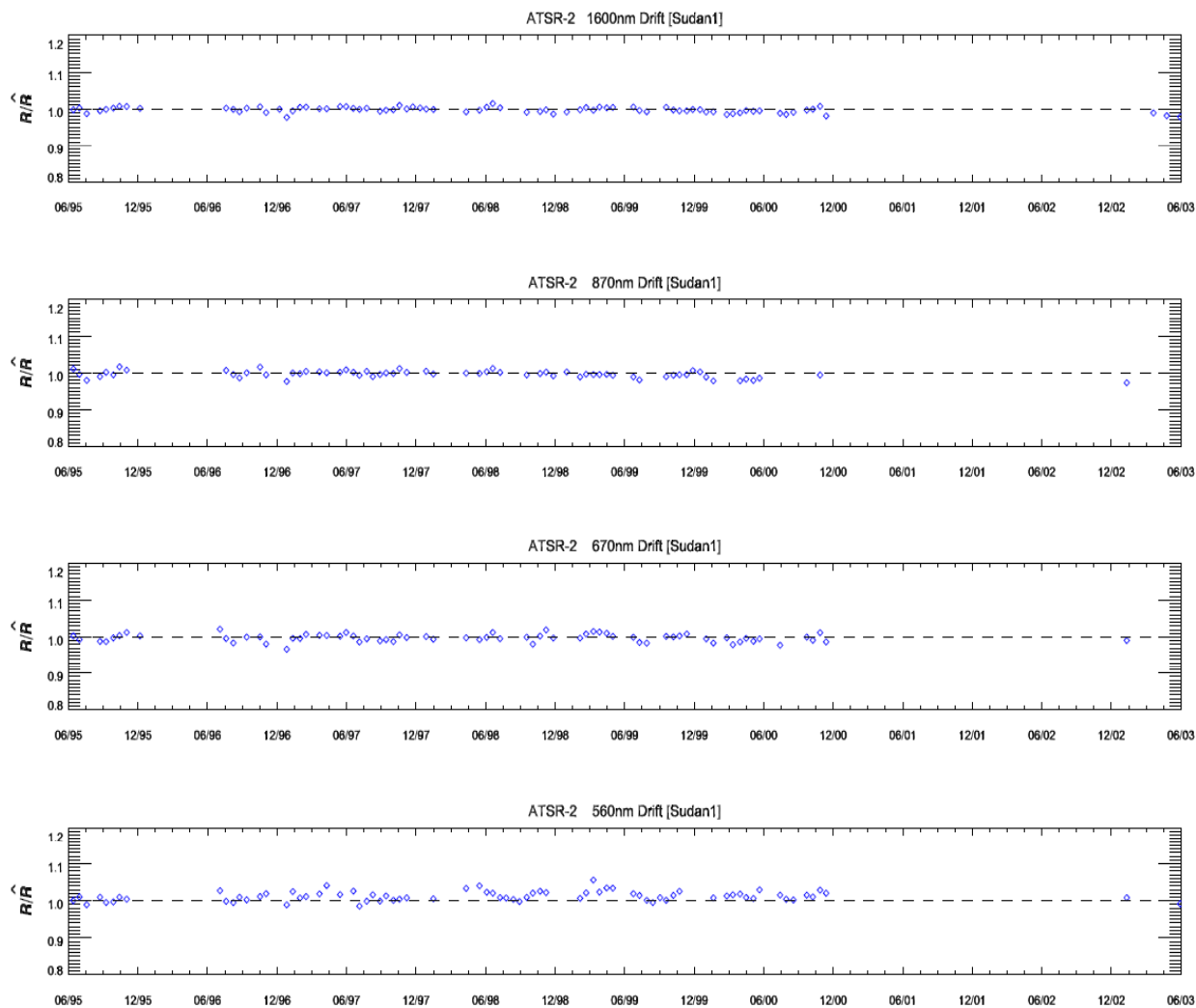

Data for SUDAN1

Data gap between  
December 2000 to  
March 2003 due to  
unprocessed data

BRDF obtained by  
fitting polynomial to  
reflectance vs.  
scattering angle

# MERIS Long Term Stability

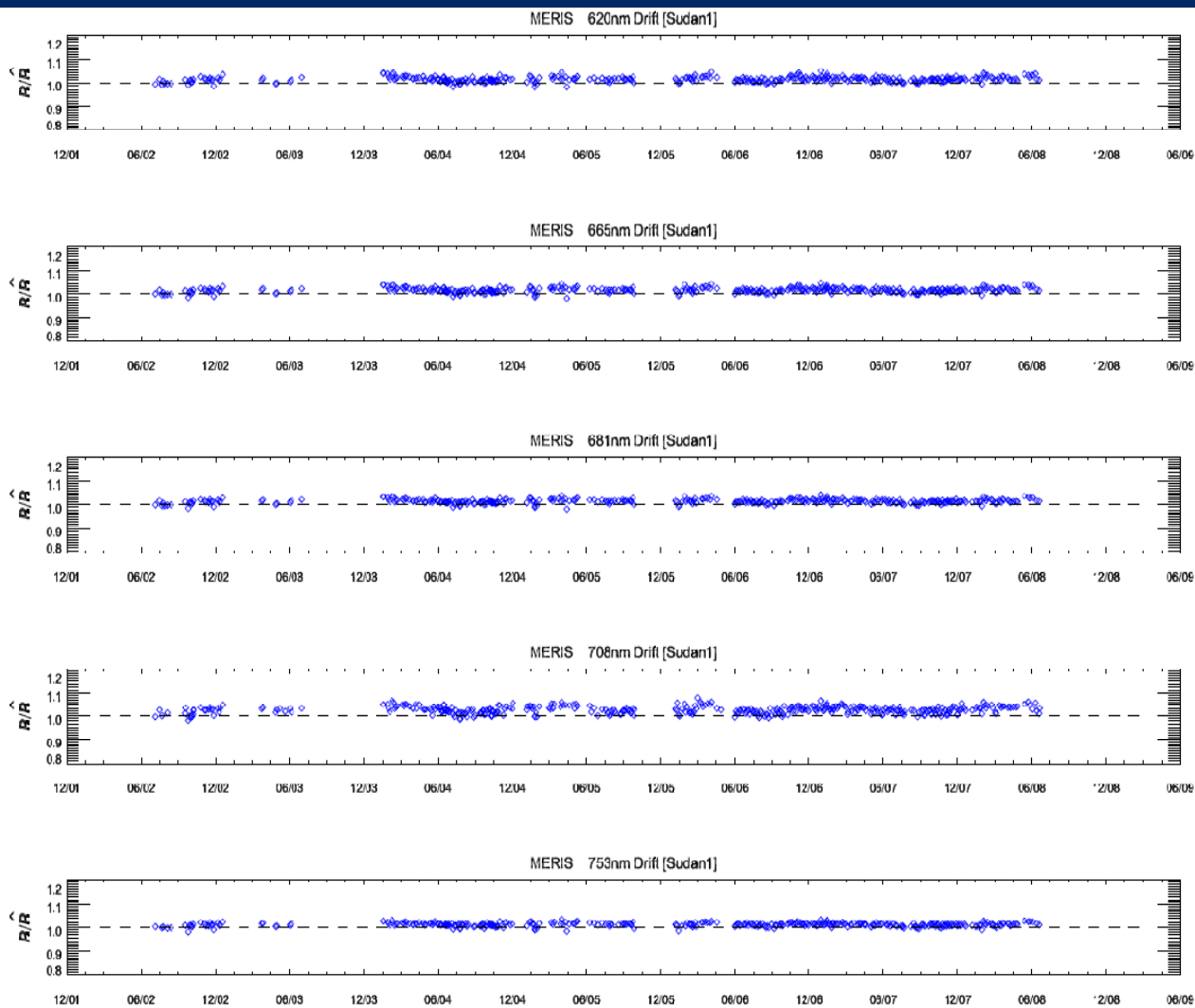

Data for SUDAN1

BRDF obtained by  
fitting polynomial to  
reflectance vs.  
scattering angle

METRIC Data extraction courtesy ACRI

# AATSR Long Term Drift – BRDF as Reference

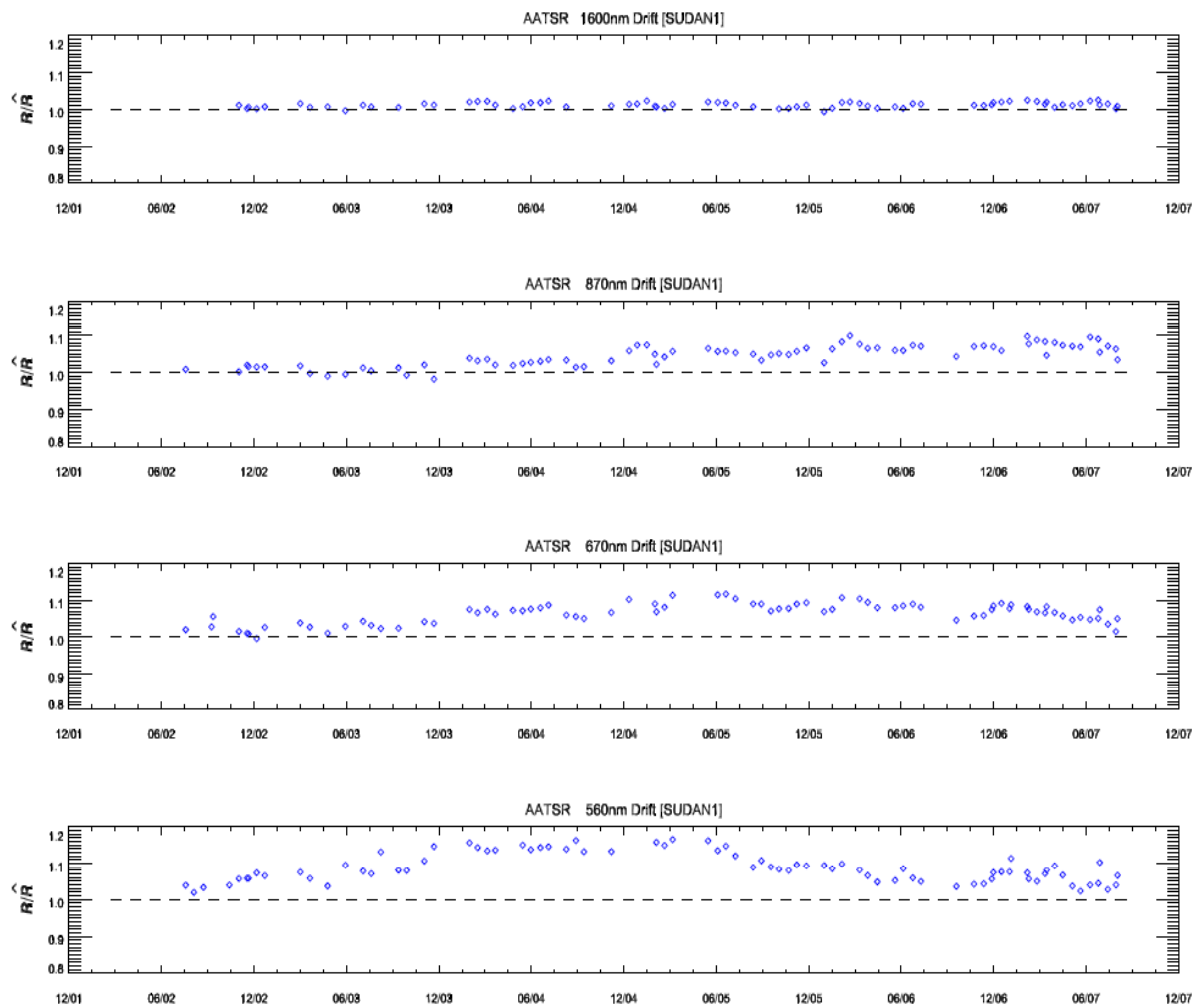

Data for SUDAN1

BRDF obtained by  
fitting polynomial to  
reflectance vs.  
scattering angle

# AATSR Long Term Drift – MERIS as Reference

- Measured biases from early intercomparisons have been removed from trend
- Ratio  $R_{\text{AATSR}}/R_{\text{MERIS}}$ 
  - 0.87 $\mu\text{m}$  = 1.034
  - 0.66 $\mu\text{m}$  = 1.002
  - 0.56 $\mu\text{m}$  = 1.034
- Gaps in data due to Missing MERIS data

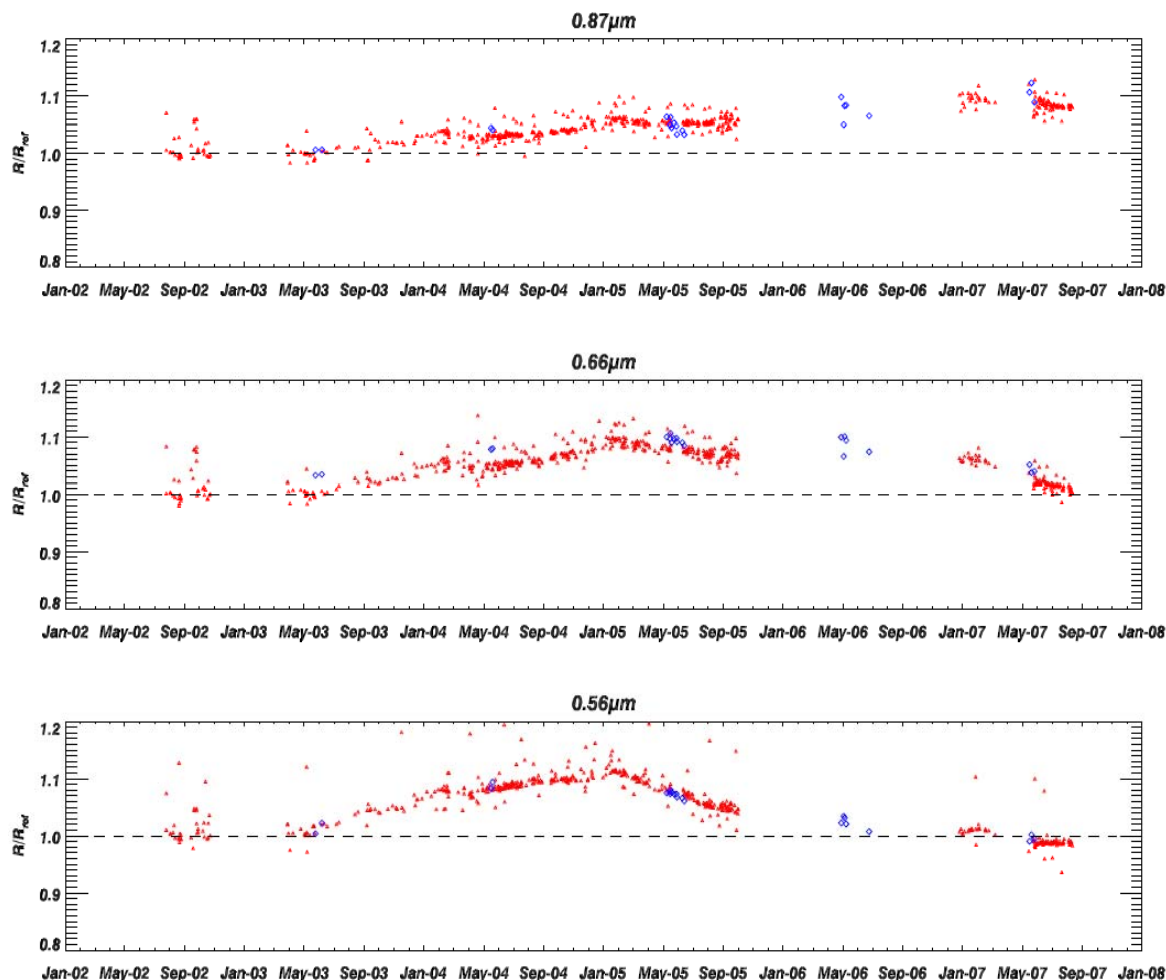

▲ All Desert Sites

◆ Greenland



# Drift Model

- For the early phase of the mission the calibration trend followed an exponential decay function as predicted from the experience of ATSR-2, AVHRR etc. such that

$$D(t) = \exp(-kt)$$

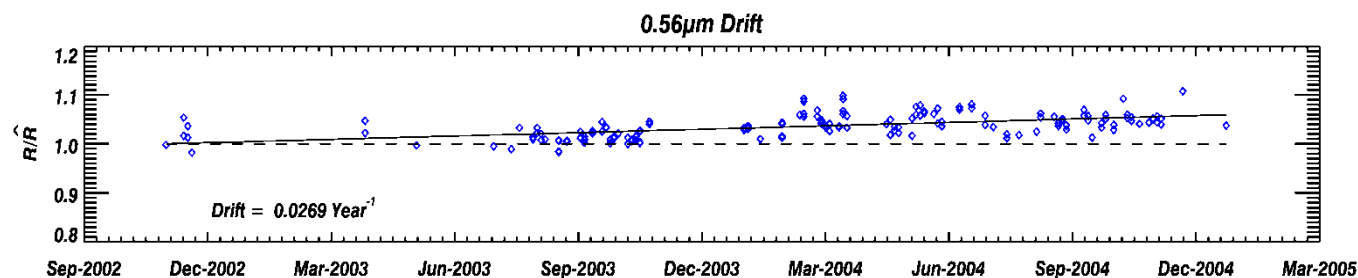

- Post 2005 data shows that the exponential decay model was incorrect in the case of the AATSR visible channels. The observed long term trends suggest that the drift is caused by a thin-film interference effect (Etalon) of the form

$$D(t) = 1 + A \sin^2(2\pi n x t / \lambda)$$

(where n is the refractive index and x is the thickness)

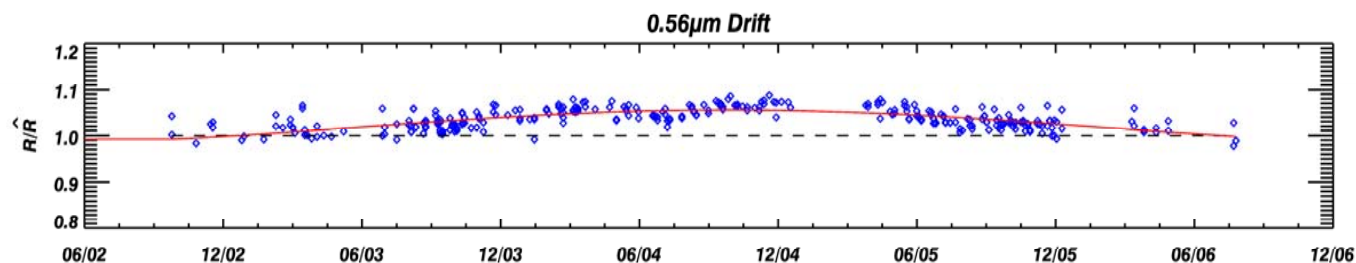

## Drift Model (2)

- Although the 'thin film' model provides a reasonable representation of the observed drift, analysis of most recent data shows that the model underestimates the trend when using the current parameters.

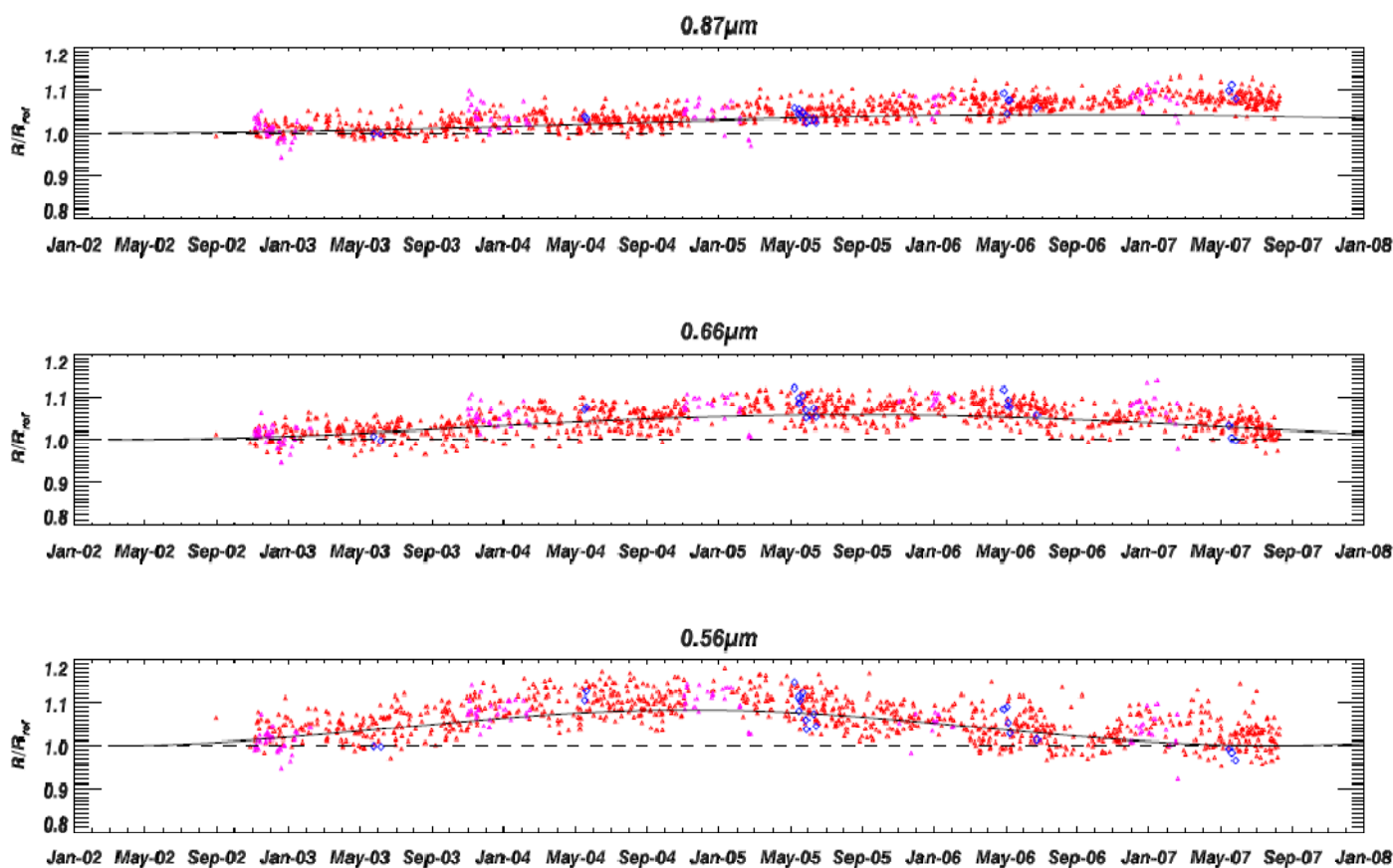

# Drift Function

- Rather than attempting to fit a parametric function to the data, it is proposed to use a smoothed average of the measurements.
- The smoothing function is given by

$$\bar{D}(t_i) = \frac{1}{N} \sum_{t_i - t_{width}/2}^{t_i + t_{width}/2} D(t)$$

- The smoothing function was then reapplied only to those measurements that fell within 2 standard deviations the running average.
- The process was repeated until there was no further improvement of the standard deviation, which was normally achieved within 5 iterations.

# Trend File

- Smoothed data are then interpolated to provide a drift value for each day which are provided in a text file –

AATSR Drift Corrections

Version : 0.1

File Generated : 15-JAN-2008 15:35:42

Boxcar Width Used :120 Days

\*\*\*\*\*

\*\*\*\*\*

#	Date	1.6 $\mu$ m	0.87 $\mu$ m	0.66 $\mu$ m	0.56 $\mu$ m
0	30-AUG-2002 12:00:00	1.00946	0.99717	1.00260	1.03206
1	31-AUG-2002 12:00:00	1.00929	0.99733	1.00266	1.03189
2	01-SEP-2002 12:00:00	1.00913	0.99749	1.00273	1.03172
3	02-SEP-2002 12:00:00	1.00897	0.99765	1.00279	1.03156
4	03-SEP-2002 12:00:00	1.00880	0.99781	1.00286	1.03139
5	04-SEP-2002 12:00:00	1.00864	0.99797	1.00293	1.03123
6	05-SEP-2002 12:00:00	1.00847	0.99813	1.00299	1.03106
7	06-SEP-2002 12:00:00	1.00831	0.99829	1.00306	1.03089
8	07-SEP-2002 12:00:00	1.00814	0.99845	1.00312	1.03073
9	08-SEP-2002 12:00:00	1.00798	0.99861	1.00319	1.03056
10	09-SEP-2002 12:00:00	1.00782	0.99877	1.00325	1.03040
11	10-SEP-2002 12:00:00	1.00765	0.99893	1.00332	1.03023
12	11-SEP-2002 12:00:00	1.00749	0.99909	1.00338	1.03007
13	12-SEP-2002 12:00:00	1.00732	0.99925	1.00345	1.02990
14	13-SEP-2002 12:00:00	1.00716	0.99941	1.00352	1.02973
15	14-SEP-2002 12:00:00	1.00700	0.99957	1.00358	1.02957
16	15-SEP-2002 12:00:00	1.00683	0.99973	1.00365	1.02940
17	16-SEP-2002 12:00:00	1.00667	0.99989	1.00371	1.02924

## How to correct drift

- It is possible to identify which corrections have been applied by checking the GC1 and VC1 filenames used in the processing.
- IDL tools have been developed to identify and implement appropriate corrections to L1B products
  - AATSR\_CORRECT\_V16\_NONLINEARITY.PRO
    - corrects 1.6um nonlinearity if not already implemented.
  - AATSR\_REMOVE\_DRIFT\_CORRECTION.PRO
    - removes existing drift correction to allow the latest and best drift corrections to be applied
  - AATSR\_APPLY\_DRIFT\_CORRECTION.PRO
    - Applies the drift correction using a look up-table containing the measured drift for each channel
- Tools and Look-Up Table to be made available on-line
- Tools have been implemented as BEAM extensions.

# AATSR Drift

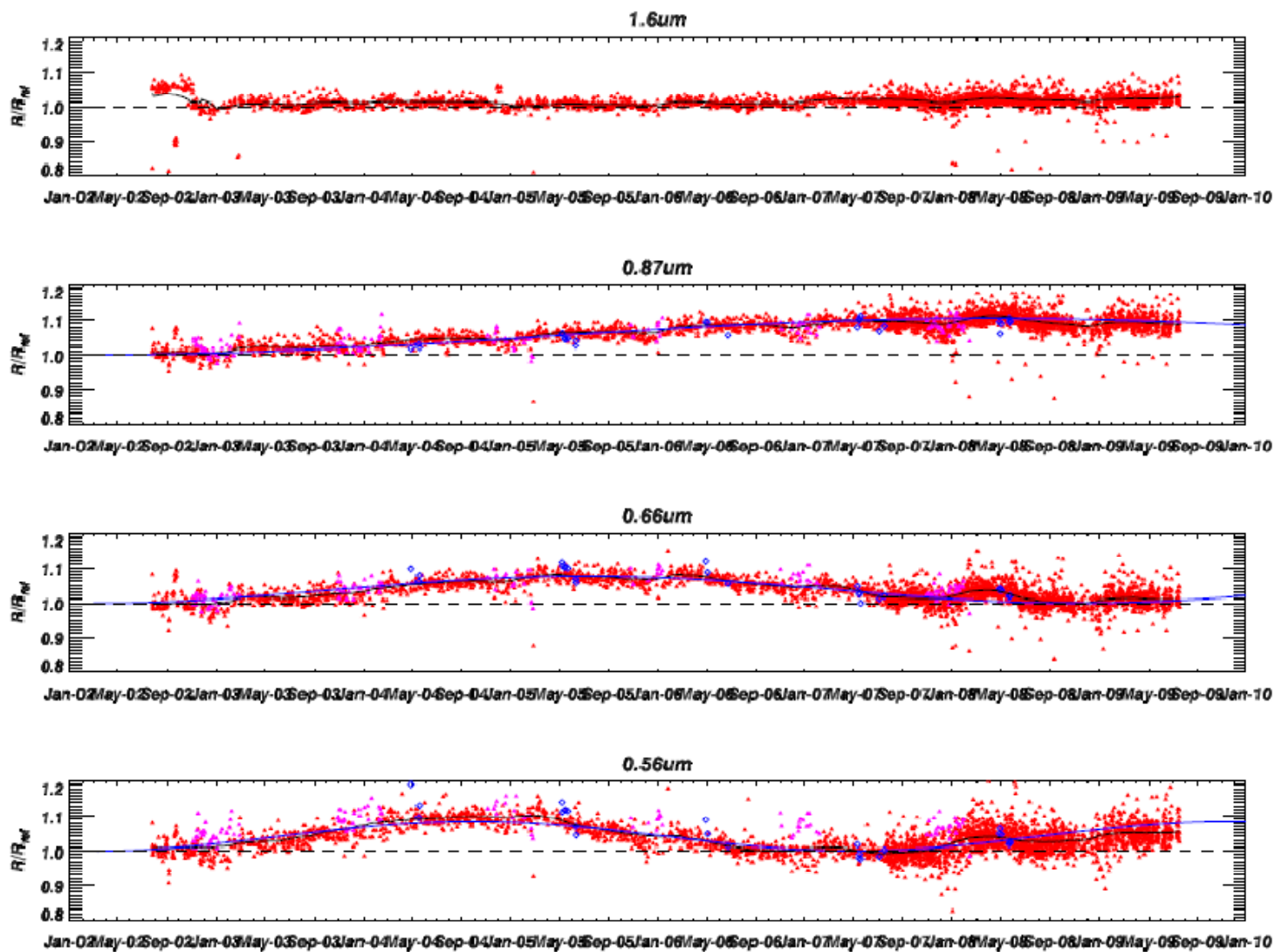

# AATSR Vs. Meris – Desert Targets

- METRIC products for Desert sites continue to be downloaded for comparison against AATSR TOA reflectances

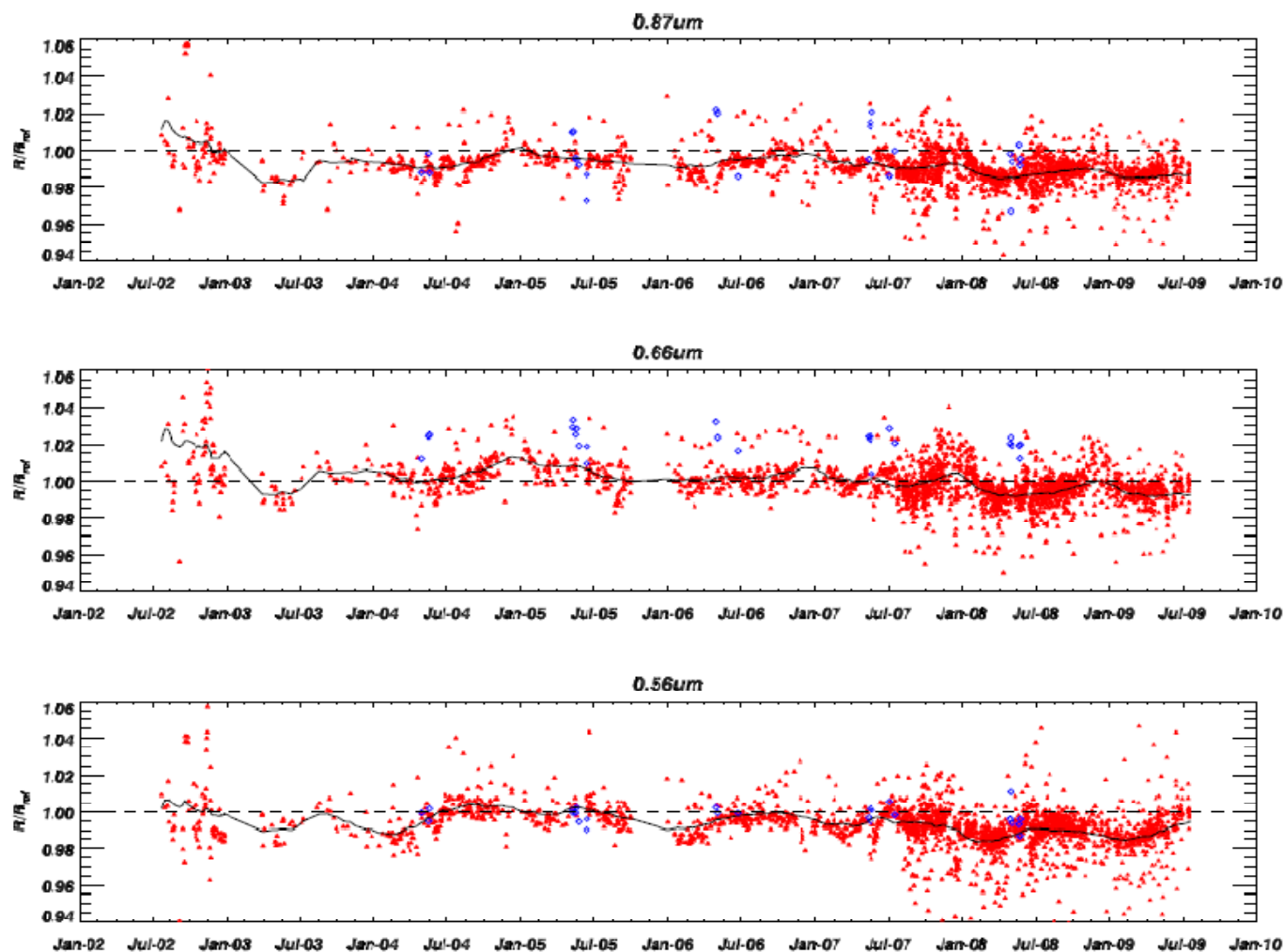

# AATSR vs. MERIS (Deserts)

- Applying drift correction to AATSR reflectances yields better agreement between AATSR and MERIS

- Revised Bias (2008)

$$R_{\text{AATSR}}/R_{\text{MERIS}}$$

$$0.87\mu\text{m} = 1.025 \pm 0.005$$

$$0.66\mu\text{m} = 1.001 \pm 0.005$$

$$0.56\mu\text{m} = 1.025 \pm 0.004$$

Comparisons over Sudan1

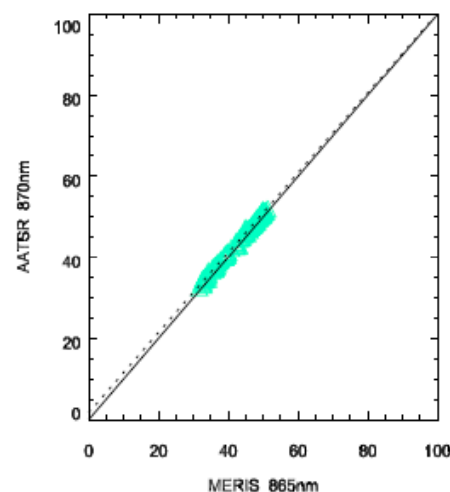
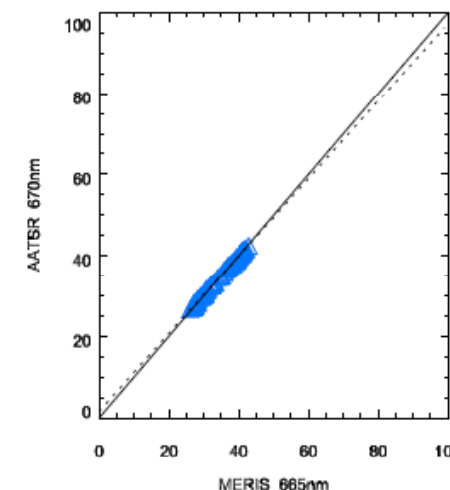
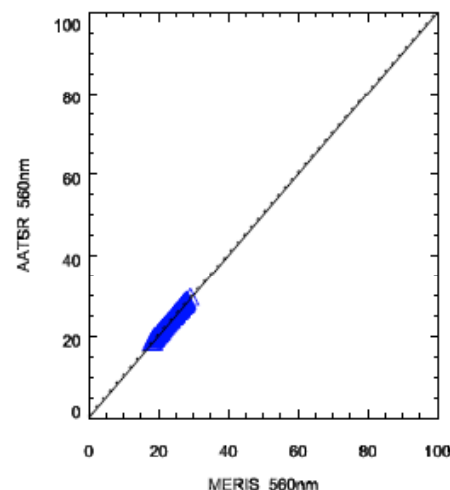



## Comparisons with ATSR-2 (Deserts)

Comparisons made with  
1995-2000 ATSR-2 data for  
same view/solar geometry

Drift correction and 1.6 $\mu$ m  
nonlinearity correction  
applied

Bias  $R_{\text{AATSR}}/R_{\text{MERIS}}$

$$1.6\mu\text{m} = 1.004 \pm 0.011$$

$$0.87\mu\text{m} = 1.091 \pm 0.015$$

$$0.66\mu\text{m} = 1.091 \pm 0.011$$

$$0.56\mu\text{m} = 1.113 \pm 0.016$$

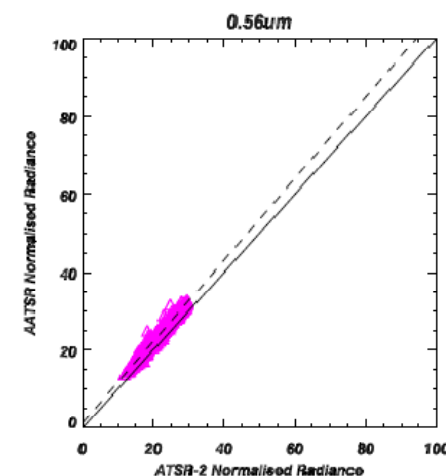
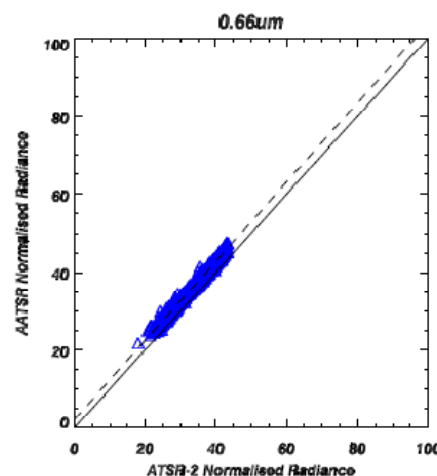
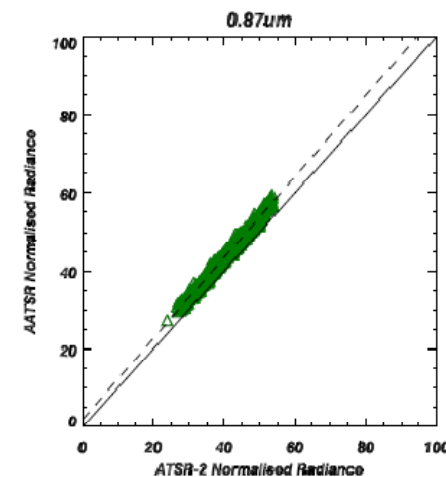
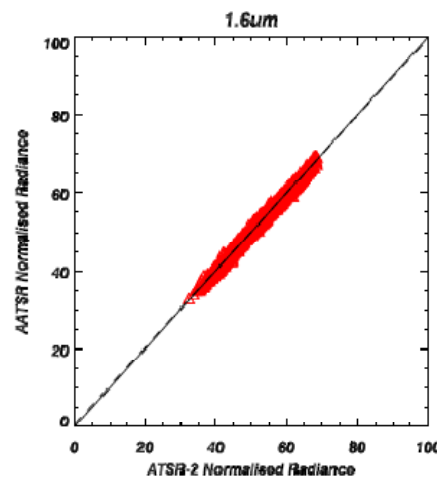

# Dome C

- Concordia Station, located on Dome C, is run jointly by France and Italy.
- During the summer there are about 40 to 50 people on station.
- During winter ~ 13 people on station



Photo courtesy Stephen Hudson, Univ. of Washington

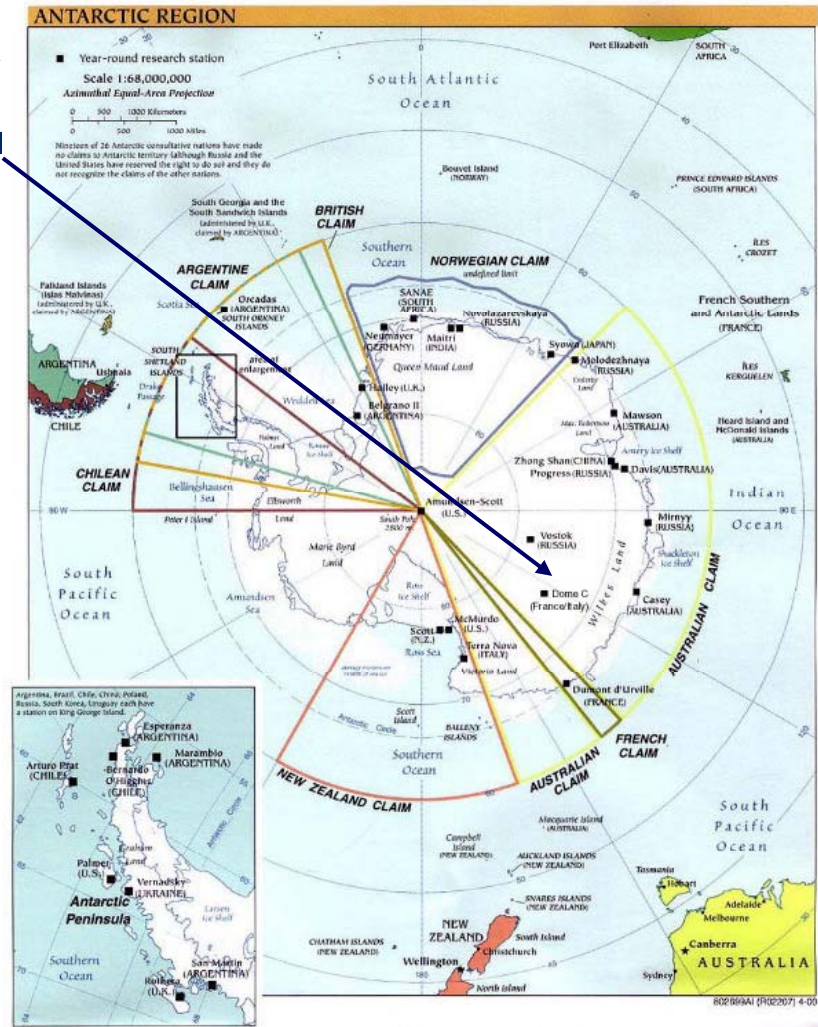

Altitude 3250 m, 10,600 feet  
 Max Temp -18°C on summer afternoons

# Dome C Characteristics

- Campaigns in summer 2003/2004 and 2004/2005 by University of Washington to characterise spectral BRF of DOME-C site (Stephen Hudson and Steven Warren et al, 2006)
- Measurements performed for wavelength range 350nm-2400nm

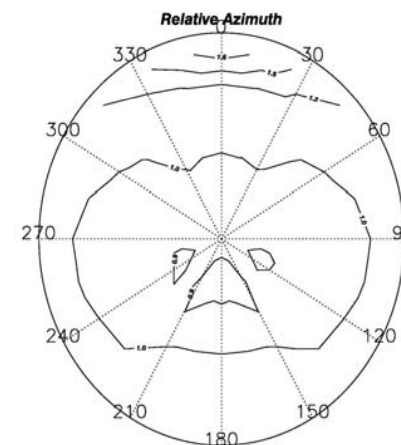
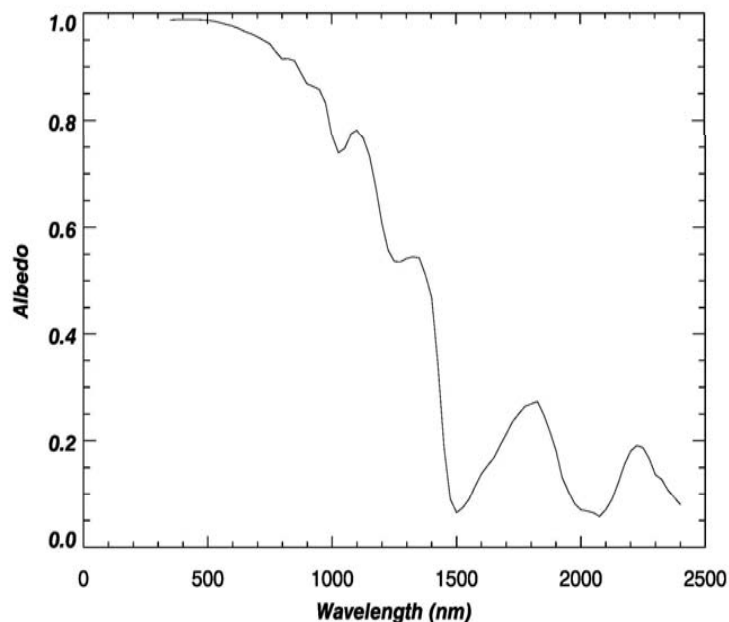

600nm

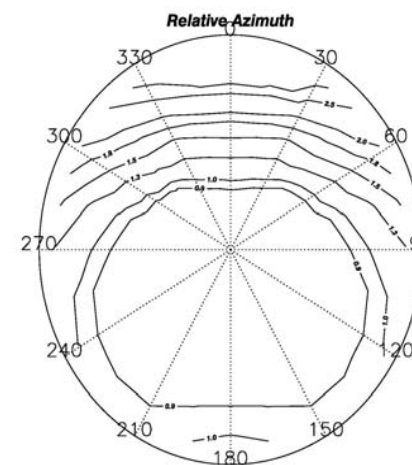

1600nm

# Dome-C Intercomparisons

- IVOS activity to perform inter-agency comparison of reflectance data over Dome-C  
ESA (RAL) – AATSR/ATSR-2/MERIS  
CNES – VGT1, VGT2, Parasol, SPOT  
NASA - MODIS
- 4 regions over Dome-C site used for comparisons
 

Site	Latitude	Longitude
Dome 1	-78.5933	120.2648
Dome 2	-75.7431	113.7356
Dome C	-75.1017	123.3950
Dome 3	-77.3825	128.715

  - Sites are 100km x 100km large centered on the above lat-long coordinates.
- BRDF measurements of Stephen Hudson et al to be used as reference
- Dome-C also used for low temperature calibration of MODIS TIR channels
  - Comparisons possible for 11um and 12um channel
  - Provides check of non-linearity calibration

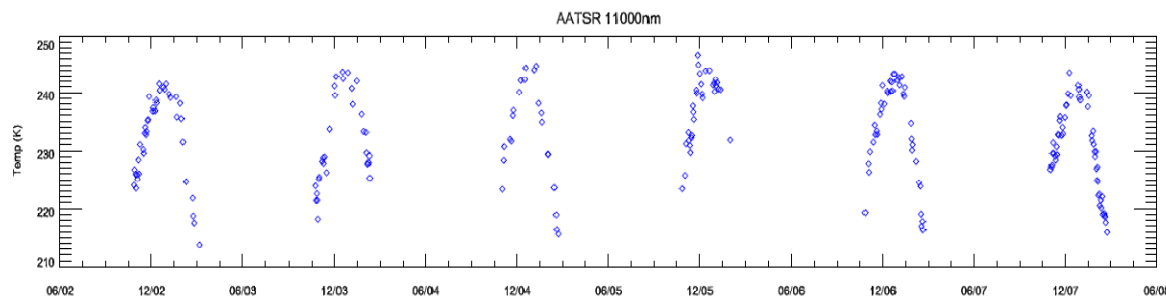

# AATSR vs. Ground Measurements – Initial Comparisons

Nadir  
View

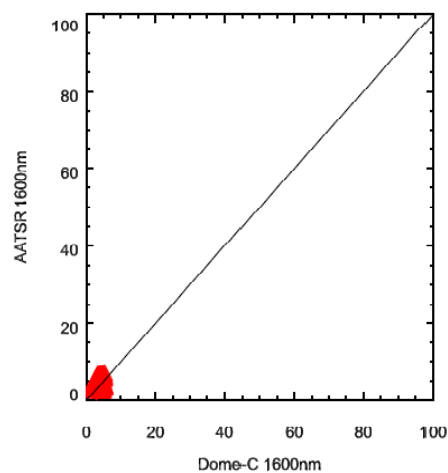
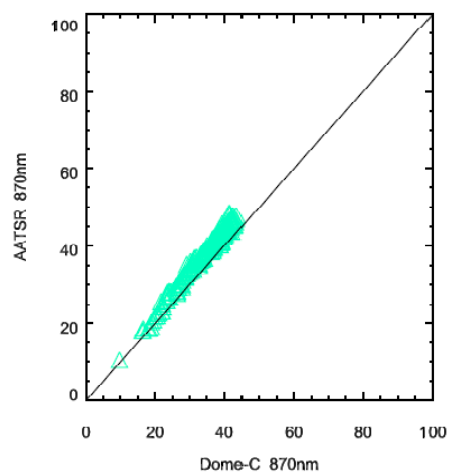
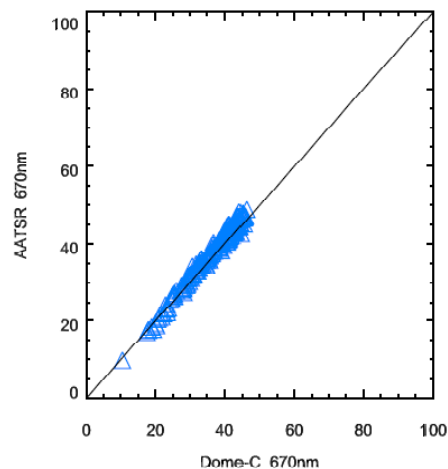
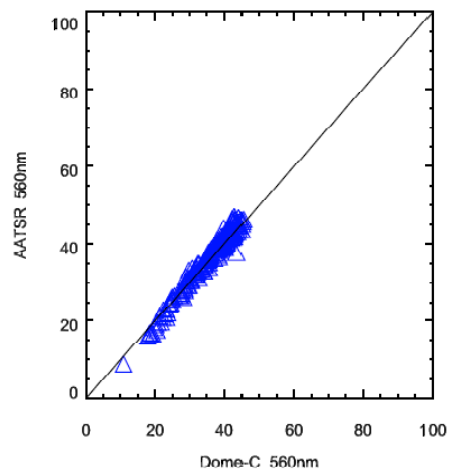

**NOTE: Only single scattering approximation for atmosphere has been applied to predict TOA reflectance – multiple scattering model to be performed**

**Mainly affects 555nm and 659nm**

# Dome-C Multi Sensor Comparison

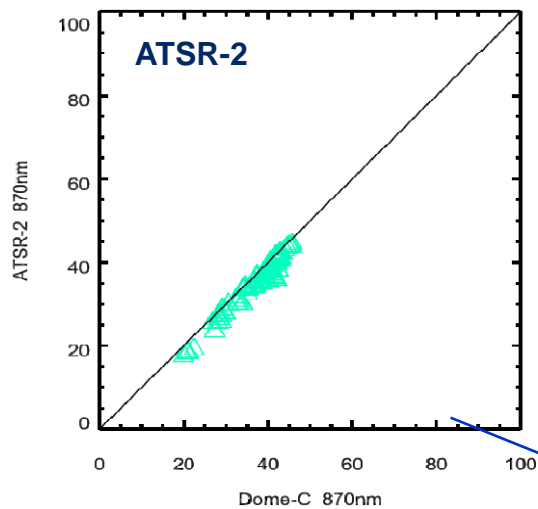

Using ground measurements of Hudson et al enables multi sensor comparisons to be made independently of overpass times

Example at 0.87μm

- Less sensitive to Rayleigh or Ozone

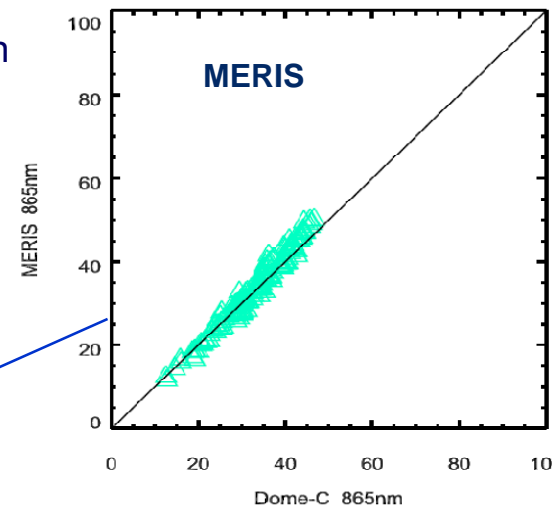

$R_{Inst}/R_{BRDF} (0.87\mu m)$

ATSR-2 = 0.961

AATSR = 1.103

MERIS = 1.031

MODIS = 1.017

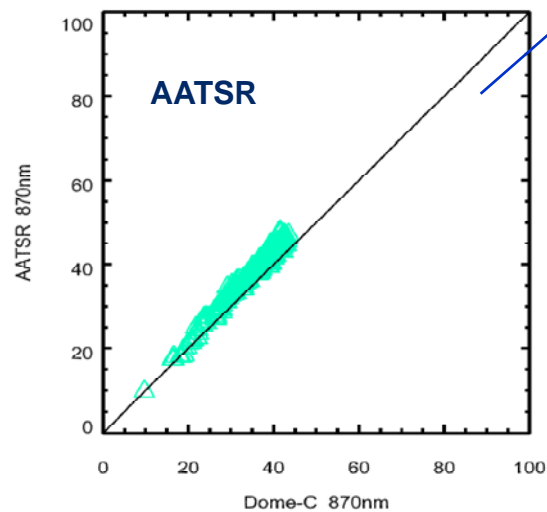

$R_{AATSR}/R_{INST} (0.87\mu m)$  {2006 result}

ATSR-2 = 1.148 {1.14}

MERIS = 1.070 {1.035}

MODIS = 1.085 {1.08}

I.e. results are consistent with early mission results.

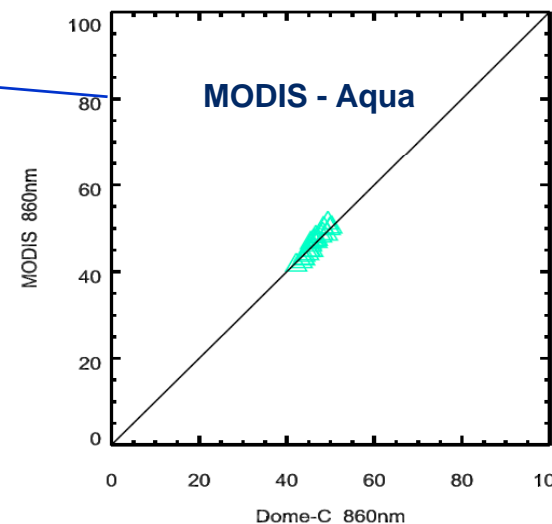

Results are preliminary!

## Data Products

- Acquisition over test sites is automatic since instruments are continuously acquiring data over daytime
  - L1b Child products are extracted using GEO-ChildGen tool
  - AATSR L1b child products are extracted from on-line archive hosted by RAL
  - MERIS L1b child products for DOME-C are extracted by Brockman Consult and transferred via ftp

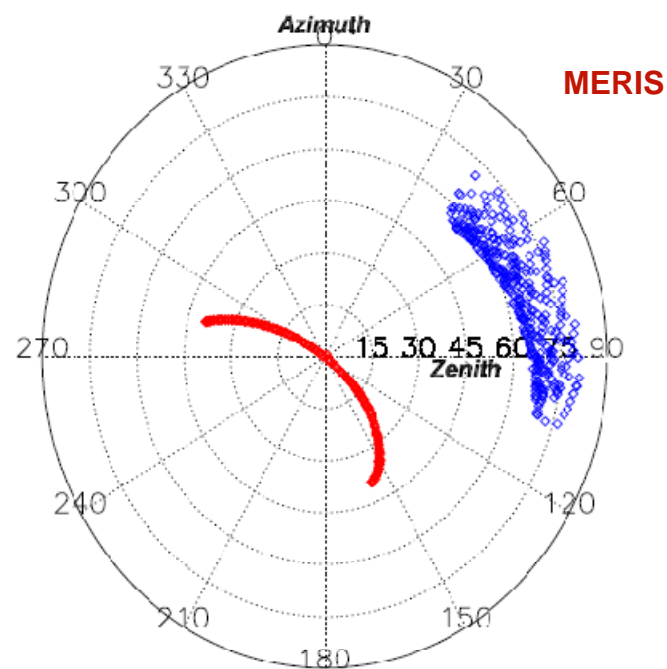
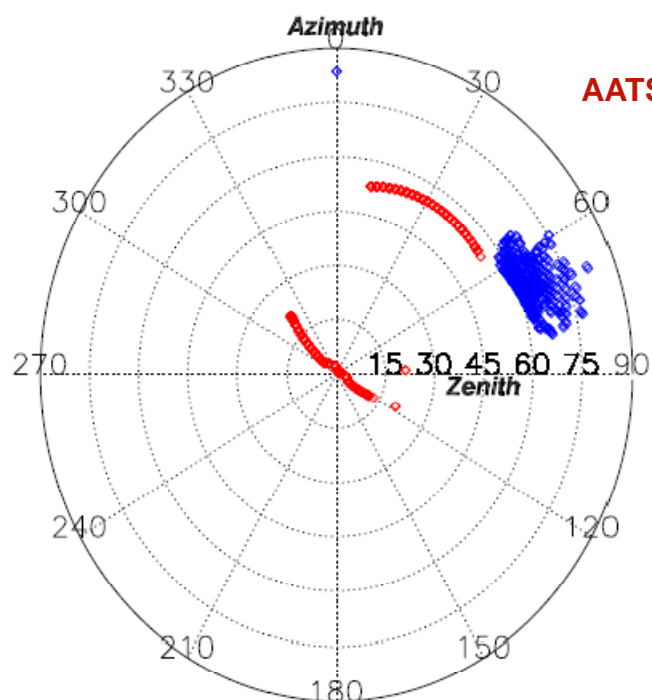

# Data Processing

- For AATSR L1b
  - Latest Drift corrections have been applied
    - See 2008 MERIS/AATSR workshop paper
- Products are first screened for ROI and Clouds
  - Product is accepted for further processing even if part of ROI is included
    - Necessary for AATSR due to narrow swath
    - If no pixels present then no further processing is performed
  - AATSR Cloud test
    - Spatial test on 0.87um and 12um channel reflectance/BT
    - Threshold test on 1.6um for water clouds
  - MERIS Cloud test
    - Spatial test on ch3(490nm) and ch13(865nm)
  - If ROI is >75% cloudy then no further processing is performed
- Average cloud free TOA normalised radiance is computed
  - =  $\text{toa\_radiance}/\text{solar\_irradiance} = \text{toa\_reflectance} * \cos(\text{sol\_zenith})$
  - Results are saved to a text file



# Preliminary Results

	$R_{AATSR}/R_{MERIS}$									
	DOME C		DOME 1		DOME 2		DOME 3		DOME 4	
Wavelength	Mean	Stdev	Mean	Stdev	Mean	Stdev	Mean	Stdev	Mean	Stdev
560nm	1.0302	0.0136	1.0237	0.0049	1.0279	0.0078	1.0226	0.0058	1.0240	0.0048
665nm	1.0229	0.0098	1.0172	0.0058	1.0197	0.0085	1.0134	0.0089	1.0172	0.0060
865nm	1.0305	0.0070	1.0260	0.0079	1.0273	0.0104	1.0166	0.0105	1.0254	0.0078

## Summary of MERIS/AATSR Comparisons

<b>Desert Results</b>	<b>560nm</b>	<b>670nm</b>	<b>870nm</b>
Mean Ratio	1.0274	1.0012	1.0246
Std Deviation	0.0041	0.0042	0.0042

### Ice Results

Mean Ratio	1.0258	1.0176	1.0256
Std Deviation	0.0029	0.0034	0.0047

### Combined Desert + Ice Data

Mean Ratio	<b>1.0266</b>	<b>1.0094</b>	<b>1.0256</b>
Error	<b>0.0050</b>	<b>0.0079</b>	<b>0.0064</b>

## Planned Activities

- Maintain operational monitoring of long-term AATSR VIS drift using desert/ice targets and implement automatic update of the correction LUT
  - Table to be made available on line via EO CALVAL portal
- Make available an on-line archive of extracted AATSR TOA reflectances for desert sites
  - i.e. METRIC for AATSR
- Define a forward projection of the AATSR gains to be used by the operational processing.
- Quantify uncertainties of the derived AATSR calibration factors
- Evaluate sensitivity of vicarious calibration to various parameters
  - solar and viewing geometries
  - BRDF Effects
  - Smile Effect
  - Detector Temperatures
  - Etc...
- Participate in IVOS led calibration activities for Tuz Golu site

# Sentinel-3 Spacecraft

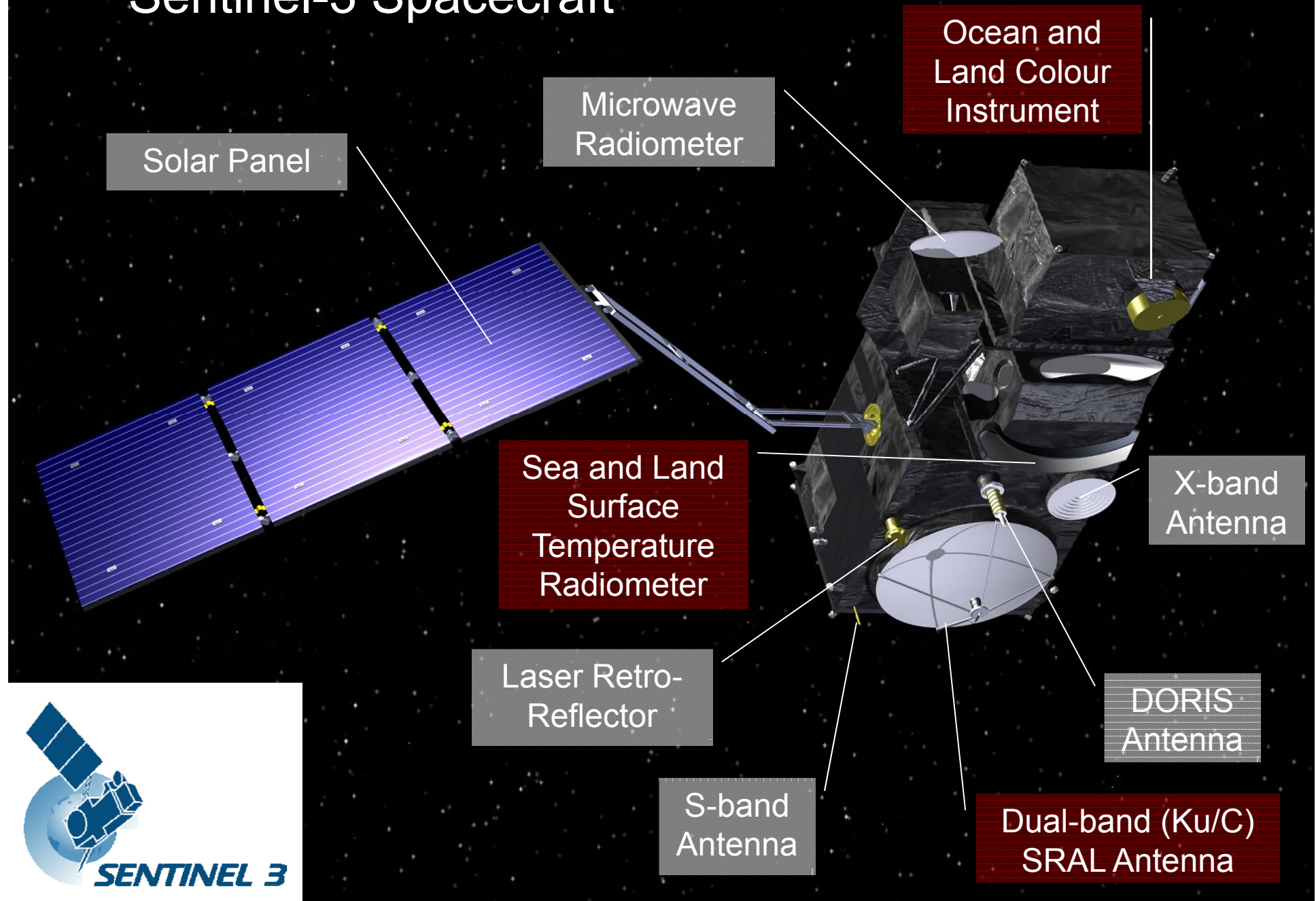

# Summary of SLSTR Main Requirements

- Extended Swath for single and double pass
- Spatial Sampling Interval (at Nadir)
  - <1km for TIR channels
  - <500m for solar channels
- Spectral Bands
  - Infrared 1.378, 1.6, 2.25, 3.7, 10.8, 12 $\mu$ m
  - Visible 0.55, 0.66 and 0.85 $\mu$ m
- Absolute radiometric accuracy
  - 0.2K for IR channels
  - 2% BOL and 5% EOL

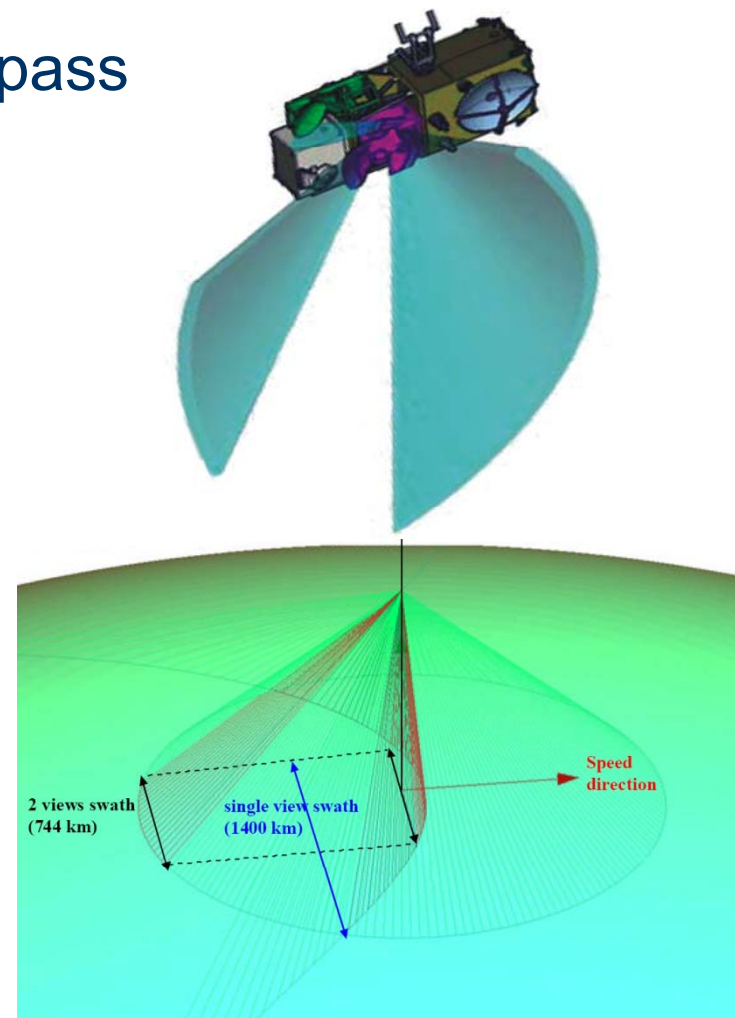

# Requirements for a Calibrated EO System

## On-Board Calibration Sources

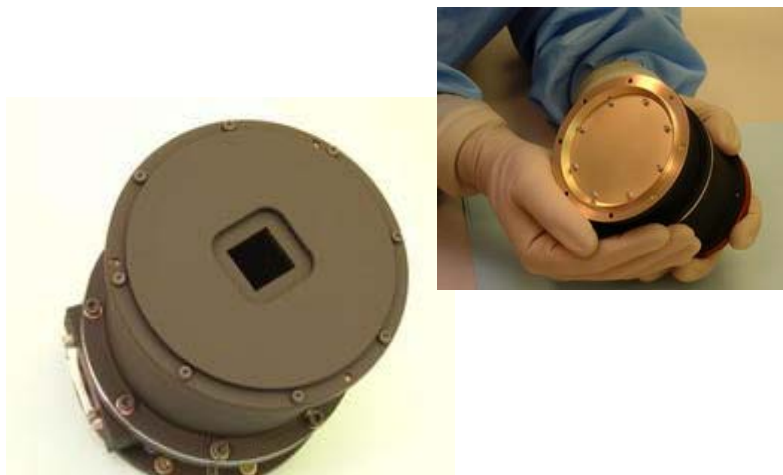

## Sustained Post Launch Activities



## Pre-Launch Calibration

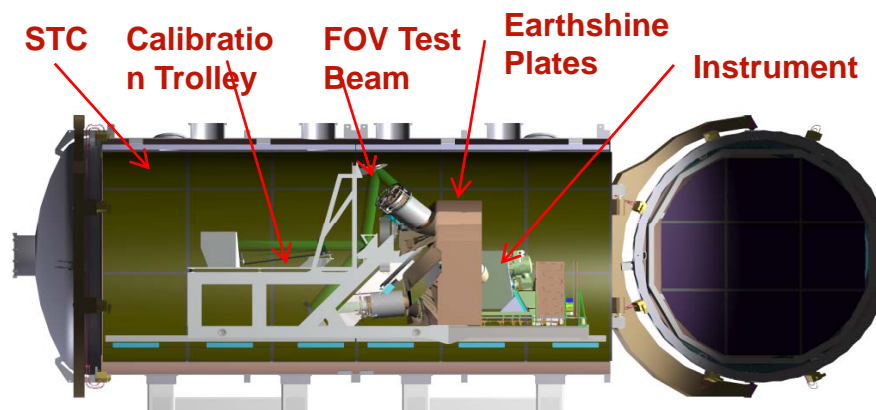

## Theoretical Modelling Radiative Transfer Code

